



400 Seventh Street, S.W.
Washington, D.C. 20590

U.S. Department
of Transportation

**National Highway
Traffic Safety
Administration**

Dear Crash Data Researchers/Users:

Thank you for choosing crash data from the National Highway Traffic Safety Administration (NHTSA) for your research or other use. The information contained in this motor vehicle crash report is collected, maintained and distributed in accordance with Public Law 89-564. In accordance with this Public Law, NHTSA is required not to release any case information until completion of quality control procedures. These procedures include a review of the case material to extract all names, licenses and registration numbers, non-coded interview material, non-research related researcher comments in the margins, non-factual data, and the production number portion of the vehicle identification number (VIN).

If you requested NHTSA to query its database files in order to identify a specific crash, then that query was made using non-personal descriptors you provided for use in our search. This motor vehicle crash may have been identified from a data search and matches the general, non-personal descriptors you provided, but we cannot confirm that this is the specific crash report you requested.

If you have any questions with regard to the above procedures, please contact the Field Operations Branch, Crash Investigation Division, National Center for Statistics and Analysis at 202-366-4820. Again, please be advised that we cannot confirm that this is the case that you have specifically requested nor can we certify the information to be correct.

*** **



AUTO SAFETY HOTLINE
(800) 424-9393
Wash. D.C. Area 366-0123



PEDESTRIAN CASE SUMMARY

PSU 40 CASE NO. 604P TYPE OF ACCIDENT CAR/PEDESTRIAN CROSSING ROAD STRAIGHT
AH

A. DESCRIPTION OF THE ACCIDENT SEQUENCE AND ACCIDENT PECULIARITIES

(Provide a summary of the accident sequence as well as any particular event of the accident that is noteworthy. Pedestrian injury mechanism and vehicle interaction is the focus, not pedestrian or driver culpability. Do not include any personal identifiers.)

PEDESTRIAN^{was} ATTEMPTING TO CROSS THE ROAD STRAIGHT, WALKING WITH A CANE, WAS STRUCK BY A NORTHBOUND VEHICLE AND THROWN 66.4 M. VEHICLE LEFT THE SCENE. PED WAS TRANSPORTED TO MEDICAL CENTER AND PRONOUNCED DEAD ON ARRIVAL. VEHICLE LATER RECOVERED.

B. PEDESTRIAN PROFILE

Pedestrian No.	Age	Sex	Treatment/Mortality	Most Severe Injury (TO BE COMPLETED BY ZONE CENTER)			
				Body Region	Ana. Struc.	AIS	Injury Source
01	72	1	FATAL	BRAINSTEM	SEVERED (LACERATION)	6	Hood Surface

Body Region	Type of Anatomic Structure	Abbreviated Injury Scale
Head	Whole Area	(1) Minor injury
Face	Vessels	(2) Moderate injury
Throat	Nerves	(3) Serious injury
Chest	Organs	(4) Severe injury
Abdomen/Pelvis	Skeletal	(5) Critical injury
Spine	Head-LOC	(6) Maximum (untreatable)
Upper Extremity	Skin-Burn	(7) Injured, unknown severity
Lower Extremity	Skin-Other	
External		

C. VEHICLE PROFILE

Vehicle No.	Class of Vehicle	Year/Make/Model	Most Severe Damage Based on Vehicle Inspection	
			Damage Plane	Damage Description
01	COMPACT UTILITY	96 Ford Explorer	FRONT	Front grille & windshield Damage.

DO NOT SANITIZE THIS FORM

6 AHP

Man critically hurt in accident

A man was critically injured late in a hit-and-run accident near _____ and _____ avenues.

The victim, whose identity was not available, was hit at about 10:20 p.m. by a minivan and dragged for more than 100 feet. The van then left the scene.

He was taken to _____ Medical Center, where he was in critical condition.



PEDESTRIAN ACCIDENT COLLISION MEASUREMENT TABLE

Primary Sampling Unit Number 40 Case Number-Stratum 6 04 P
AT

PEDESTRIAN ACCIDENT COLLISION DATA COLLECTION		SCALED DIAGRAM
* document reference point and reference line relative to physical features	Surface Type <u>ASPHALT</u>	* north arrow placed on diagram
* documentation of all accident induced physical evidence including (if applicable):	Surface Condition <u>WET</u>	* grade measurements for all applicable roadways
a) vehicle skid marks	Coefficient of Friction _____	* scaled representations of the physical plant including:
b) pedestrian contacts with ground or object	Grade (v/h) Measurement	a) all road/roadway delineation (e.g., crosswalks, curb/edge lines, lane markings, medians, pavement markings, parked vehicles, poles, signs, etc.)
c) vehicle/pedestrian point of impact (POI)	a) at impact <u>LEVEL</u>	b) all traffic controls (e.g., lights, signs)
d) location of pedestrian separation point from vehicle	b) between impact and final rest <u>1</u>	* scaled representations of the vehicle and pedestrian at pre-impact, impact, and final rest based upon either:
f) final resting points (FRP) for pedestrian and vehicle	Pedestrian Travel Direction <u>WEST</u>	a) physical evidence, or
* documentation of the physical plant including:	Vehicle Travel Direction <u>NORTH</u>	b) reconstructed accident dynamics
a) all road/roadway delineation (e.g., crosswalks, curb/edge lines, lane markings, medians, pavement markings, parked vehicles, poles, signs, etc.)	Number of Travel Lanes <u>4</u>	
b) all traffic controls (e.g., lights, signs)		

Reference Point: POLE Reference Line: EAST CURBLINE

Item	Distance and Direction from Reference Point	Distance and Direction from Reference Line
R.I.P.	0.0	0.7E
✓ EVIDENCE #1 SHOE	12.7 S	5.3 W
✓ EVIDENCE #2 POSS POI	15.7 S	6.5 W
✓ #3 DEBRIS	1.4 S	9.0 W
✓ #4 FRP PED	28.4 N	9.4 W
✓ #5 WATCH	18.0 N	6.5 W
✓ POLE #	28.6 N	15.8 W
✓ POLE #	25.0 S	15.8 W
✓ Parking Meter #1 FM1	7.2 S	0.6 E
✓ #2 FM2	0.8 N	0.6 E
✓ #3 FM3	17.0 N	0.6 E



U.S. Department of Transportation
National Highway Traffic Safety
Administration

ACCIDENT COLLISION DIAGRAM

BEST AVAILABLE

NATIONAL ACCIDENT SAMPLING SYSTEM
CRASHWORTHINESS DATA SYSTEM

AH

PSU No. 40

Case Number—Stratum 604P

Indicate
North

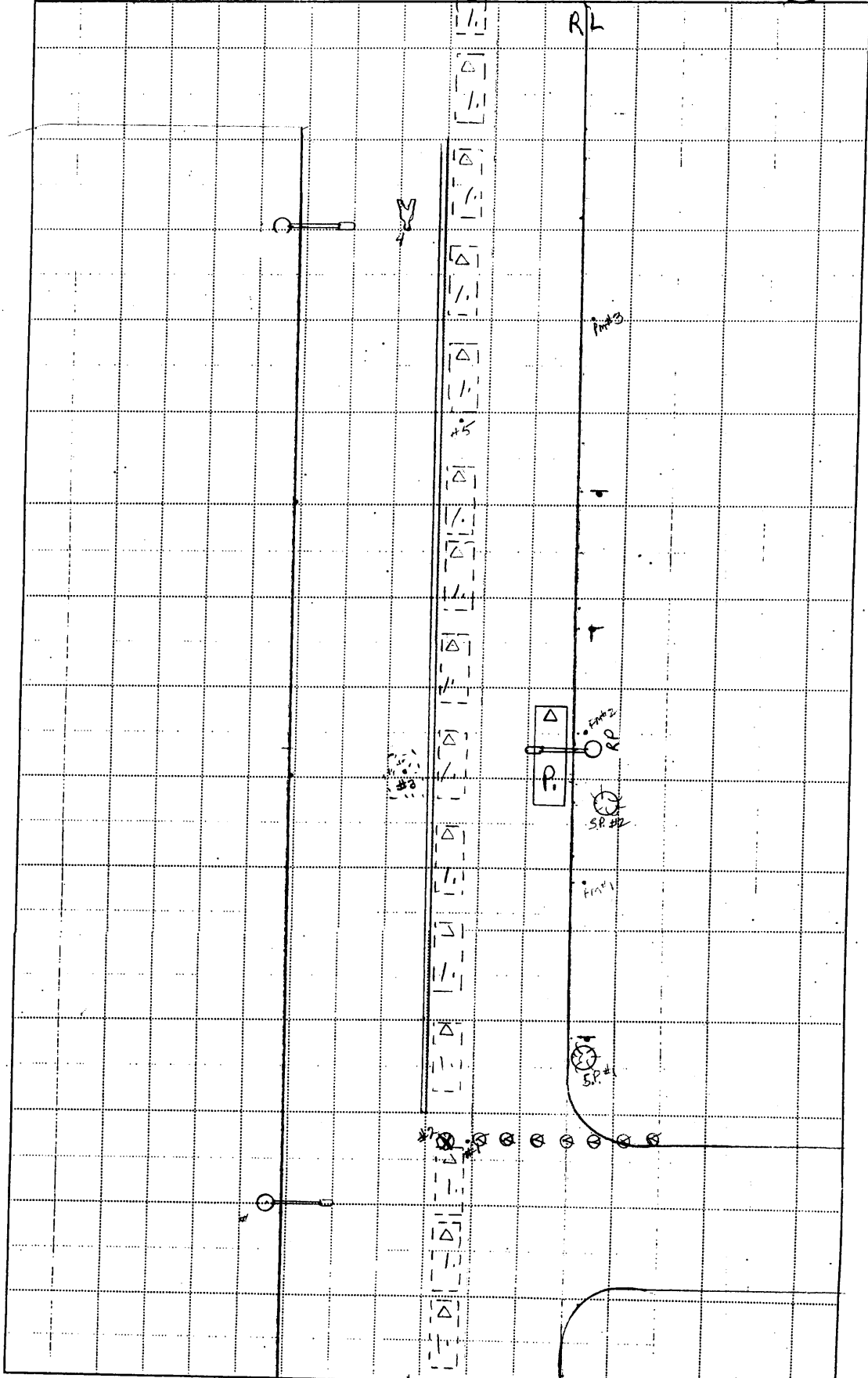

ACCIDENT COLLISION DIAGRAM

NATIONAL ACCIDENT SAMPLING SYSTEM
CRASHWORTHINESS DATA SYSTEM

PSU No. 40 Case Number—Stratum 604P
AA

Indicate North 

Draw

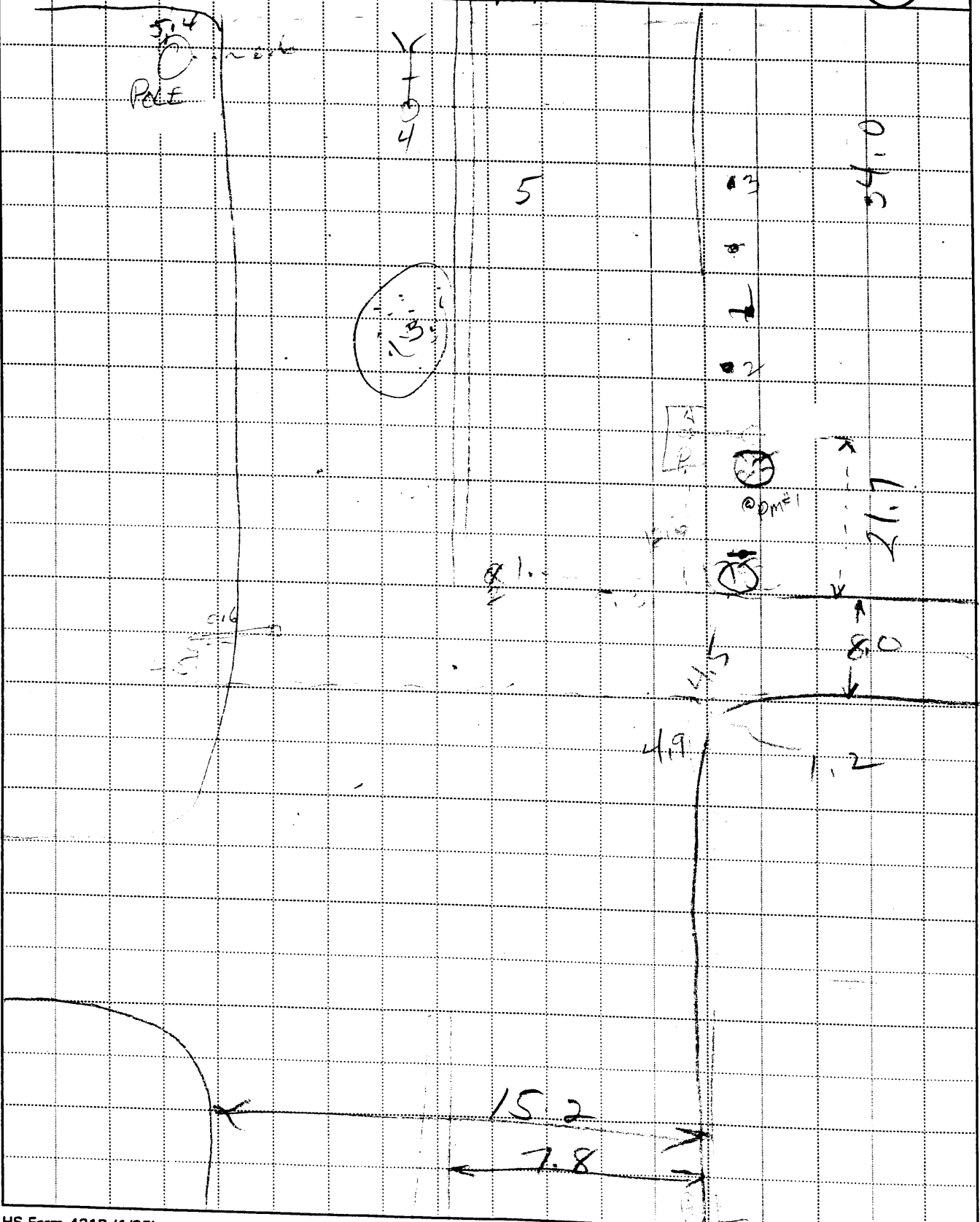

604 P
AH

BEST AVAILABLE

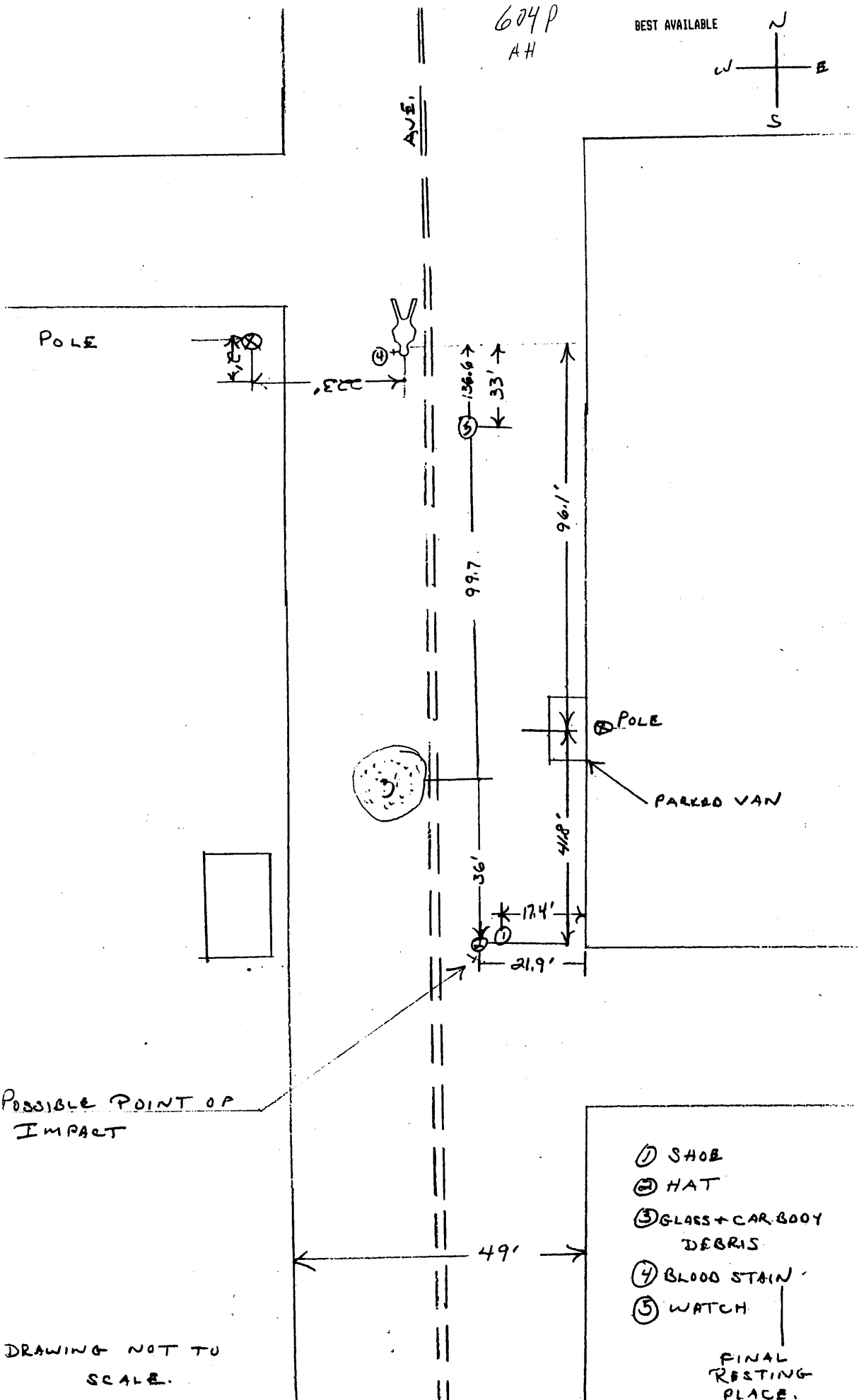
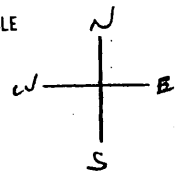

POSSIBLE POINT OF IMPACT

DRAWING NOT TO SCALE.

- ① SHOE
- ② HAT
- ③ GLASS + CAR BODY DEBRIS
- ④ BLOOD STAIN
- ⑤ WATCH

FINAL RESTING PLACE.



PEDESTRIAN ACCIDENT FORM NATIONAL ACCIDENT SAMPLING SYSTEM
PEDESTRIAN CRASH DATA STUDY

1. Primary Sampling Unit Number 40
2. Case Number - Stratum 6 04 P
HH

IDENTIFICATION

3. Number of General Vehicle Forms Submitted 0 1
4. Date of Accident (Month,Day,Year) 1 98
5. Time of Accident 2224
Code reported military time of accident.
NOTE: Midnight = 2400
Unknown = 9999

SPECIAL STUDIES - INDICATORS

Check (✓) each special study (SS15-SS19 below) that has been completed; code 1 for the checked special studies and 0 for the special studies not checked.

6. ___SS15 Administrative Use 0
7. SS16 Pedestrian Crash Data Study 1
8. ___SS17 Impact Fires 0
9. ___SS18 _____ 0
10. ___SS19 _____ 0

NUMBER OF EVENTS

11. Number of Recorded Events in This Accident 0 1

PEDESTRIAN STUDY CRITERIA

Pedestrian Definition:
Any person who is on a trafficway or on a sidewalk or path contiguous with a trafficway, or on private property (e.g., parking lot). Note: Pedestrians include persons who are in contact with the ground, roadway, etc. and are pushing carts, wagons, etc. or holding on to a vehicle.
Persons in or on a nonmotorist conveyance are not pedestrians and are excluded from this study. A nonmotorist conveyance is defined as any human powered device by which a nonmotorist may move, or by which a pedestrian or nonmotorist may move another nonmotorist. A nonmotorist conveyance for purposes of this study includes the following: bicycles, baby carriages, roller skates/blades, push carts, scooters, wheelchairs, animals, etc. For example, persons on a bicycle/scooter, roller skating/blading, in a baby carriage/push cart/wheelchair or on a horse are excluded.

Case Selection Criteria:
A forward moving, late model year (VEH04 equals 90 to 95) CDS applicable vehicle (VEH07 equals 01 to 49) must strike a pedestrian.
The striking portion of the vehicle structure must be original equipment manufacturer (OEM) without previous damage and or parts removed in the impact area. For example, vehicles equipped with deer guards, winches, snow plows, etc. or previously damaged in the impact area are excluded.
The pedestrian may not be lying or sitting.
The pedestrian impact(s) are the vehicle's only impact(s). If multiple pedestrians are impacted, each pedestrian shall be a separate case.
The first point of contact between the late model year, CDS applicable vehicle and the pedestrian must be forward of the top of the A pillar.

PEDESTRIAN ACCIDENT EVENTS

Accident Event Sequence Number	Vehicle Number	Class Of Vehicle	General Area of Damage	Vehicle Number or Object Contacted	Class Of Vehicle	General Area of Damage
12. <u>0 1</u>	13. <u>0 1</u>	14. <u>1 1</u>	15. <u>F</u>	16. <u>7 2</u>	17. <u>0 0</u>	18. <u>0</u>

**CODES FOR
CLASS OF VEHICLE**

- (00) Not a motor vehicle
- (01) Subcompact/mini (wheelbase < 254 cm)
- (02) Compact (wheelbase ≥ 254 but < 265 cm)
- (03) Intermediate (wheelbase ≥ 265 but < 278 cm)
- (04) Full size (wheelbase ≥ 278 but < 291 cm)
- (05) Largest (wheelbase ≥ 291 cm)
- (09) Unknown passenger car size
- (11) Compact utility vehicle
- (12) Large utility vehicle (≤ 4,500 kgs GVWR)
- (13) Passenger van (≤ 4,500 kgs GVWR)
- (14) Other van (≤ 4,500 kgs GVWR)
- (15) Pickup truck (≤ 4,500 kgs GVWR)
- (18) Other truck (≤ 4,500 kgs GVWR)
- (19) Unknown light truck type

**CODES FOR GENERAL AREA
OF DAMAGE (GAD)**

**CDS APPLICABLE
VEHICLES**

- (F) Front
- (R) Right side
- (L) Left side
- (U) Undercarriage
- (9) Unknown

CODES FOR VEHICLE NUMBER OR OBJECT CONTACTED

Collision with Nonfixed Object

- (72) Pedestrian



1. Primary Sampling Unit Number 40
 2. Case Number - Stratum 6 04 P
AF
 3. Vehicle Number 01

VEHICLE IDENTIFICATION

4. Vehicle Model Year 96
 Code the last two digits of the model year
 (99) Unknown

5. Vehicle Make (specify): 12
FORD
 Applicable codes are found in your
 NASS PCDS Data Collection, Coding and
 Editing Manual.
 (99) Unknown

6. Vehicle Model (specify): 401
EXPLORER
 Applicable codes are found in your
 NASS PCDS Data Collection, Coding and
 Editing Manual.
 (99) Unknown

7. Body Type 14
 Note: Applicable codes may be found on
 the back of this page.

8. Vehicle Identification Number
1FMCU24X1TU
 1 2 3 4 5 6 7 8 9 10 11 12 13 14 15 16 17
 Left justify; Slash zeros and letter Z (0 and Z)
 No VIN—Code all zeros
 Unknown—Code all nines

OFFICIAL RECORDS

9. Police Reported Travel Speed 999
 Code to the nearest kmph (NOTE: 000 means
 less than 0.5 kmph)
 (160) 159.5 kmph and above
 (999) Unknown
 ___ mph X 1.6093 = ___ kmph

10. Speed Limit 048
 (000) No statutory limit
 Code posted or statutory speed limit
 in kmph
 (999) Unknown
30 mph X 1.6093 = 48 kmph

11. Police Reported Alcohol Presence For Driver 9
 (0) No alcohol present
 (1) Yes alcohol present
 (7) Not reported
 (8) No driver present
 (9) Unknown

12. Alcohol Test Result For Driver 96
 Code actual value (decimal implied
 before first digit—0.xx)
 (95) Test refused
 (96) None given
 (97) AC (Alcohol Content) test
 performed, results unknown
 (98) No driver present
 (99) Unknown
 Source: _____

13. Police Reported Other Drug Presence
 For Driver 9
 (0) No other drug(s) present
 (1) Yes other drug(s) present
 (7) Not reported
 (8) No driver present
 (9) Unknown

14. Other Drug Specimen Test Result
 For Driver 9
 (0) No specimen test given
 (1) Drug not found in specimen
 (2) Drug found in specimen
 (specify): _____
 (3) Specimen test given, results
 unknown or not obtained
 (8) No driver present
 (9) Unknown

CODES FOR BODY TYPE

CDS APPLICABLE VEHICLES

Automobiles

- (01) Convertible (excludes sun-roof, t-bar)
- (02) 2-door sedan, hardtop, coupe
- (03) 3-door/2-door hatchback
- (04) 4-door sedan, hardtop
- (05) 5-door/4-door hatchback
- (06) Station wagon (excluding van and truck based)
- (07) Hatchback, number of doors unknown
- (08) Other automobile type (specify): _____

- (09) Unknown automobile type

Automobile Derivatives

- (10) Auto based pickup (includes El Camino, Caballero, Ranchero, Brat, and Rabbit pickup)
- (11) Auto based panel (cargo station wagon, auto based ambulance/hearse)
- (12) Large limousine - more than four side doors or stretched chassis
- (13) Three-wheel automobile or automobile derivative

Utility Vehicles (≤ 4,500 kgs GVWR)

- (14) Compact utility (Jeep CJ-2 - CJ-7, Scrambler, Golden Eagle, Renegade, Laredo, Wrangler, Cherokee [84 and after], Dispatcher, Raider, Bronco II, Bronco [76 and before], Explorer, S-10 Blazer, Geo Tracker, Bravada, S-15 Jimmy, Thing, Pathfinder, Trooper, Trooper II, Rodeo, Amigo, Navajo, 4-Runner, Montero, Samurai, Sidekick, Rocky)
- (15) Large utility (includes Jeep Cherokee [83 and before], Ramcharger, Trailduster, Bronco-fullsize [78 and after], fullsize Blazer, fullsize Jimmy, Landcruiser, Rover, Scout)
- (16) Utility station wagon (Chevy Suburban, GMC Suburban, Travelall, Grand Wagoneer, includes suburban limousine)
- (19) Utility, unknown body type

Van Based Light Trucks (≤ 4,500 kgs GVWR)

- (20) Minivan (Chrysler Town and Country, Caravan, Grand Caravan, Voyager, Grand Voyager, Mini-Ram, Dodge/Plymouth Vista, Aerostar, Villager, Lumina APV, Trans Sport, Silhouette, Astro, Safari, Toyota Van, Toyota Minivan, Previa, Nissan Minivan, Quest, Mitsubishi Minivan, Vanagon/Camper.)
- (21) Large van (B150-B350, Sportsman, Royal, Maxiwagon, Ram, Tradesman, Voyager [83 and before], E150-E350, Econoline, Clubwagon, Chateau, G10-G30, Chevy Van, Beauville, Sport Van, G15-G35, Rally Van, Vandura.)
- (22) Step van or walk-in van (≤ 4,500 kgs GVWR)
- (23) Van based motorhome (≤ 4,500 kgs GVWR)
- (24) Van based school bus (≤ 4,500 kgs GVWR)
- (25) Van based other bus (≤ 4,500 kgs GVWR)
- (28) Other van type (Hi-Cube Van, Kary) (specify): _____

- (29) Unknown van type

Light Conventional Trucks (Pickup style cab, ≤ 4,500 kgs GVWR)

- (30) Compact pickup (D50, Colt P/U, Ram 50, Dakota, Arrow Pickup [foreign], Ranger, Courier, S-10, T-10, LUV, S-15, T-15, Sonoma, Datsun/Nissan Pickup, P'up, Mazda Pickup, Toyota Pickup, Mitsubishi Pickup)
- (31) Large Pickup (Jeep Pickup, Comanche, Ram Pickup, D100-D350, W100-W350, F100-F350, C10-C35, K10-K35, R10-R35, V10-V35, Silverado, Sierra, R100-R500,)

- (32) Pickup with slide-in camper
- (33) Convertible pickup
- (39) Unknown pickup style light conventional truck type

Other Light Trucks (≤ 4,500 kgs GVWR)

- (40) Cab chassis based (includes rescue vehicles, light stake, dump, and tow truck)
- (41) Truck based panel
- (42) Light truck based motorhome (chassis mounted)
- (45) Other light conventional truck type
- (48) Unknown light truck type
- (49) Unknown light vehicle type (automobile, utility, van, or light truck)

OTHER VEHICLES

Buses (Excludes Van Based)

- (50) School bus (designed to carry students, not cross country or transit)
- (58) Other bus type (e.g., transit, intercity, bus based motorhome) (specify): _____
- (59) Unknown bus type

Medium/Heavy Trucks (> 4,500 kgs GVWR)

- (60) Step van (> 4,500 kgs GVWR)
- (61) Single unit straight truck (4,500 kgs < GVWR ≤ 8,850 kgs)
- (62) Single unit straight truck (8,850 kgs < GVWR ≤ 12,000 kgs)
- (63) Single unit straight truck (> 12,000 kgs GVWR)
- (64) Single unit straight truck, GVWR unknown
- (65) Medium/heavy truck based motorhome
- (67) Truck-tractor with no cargo trailer
- (68) Truck-tractor pulling one trailer
- (69) Truck-tractor pulling two or more trailers
- (70) Truck-tractor (unknown if pulling trailer)
- (78) Unknown medium/heavy truck type
- (79) Unknown truck type (light/medium/heavy)

Motored Cycles (Does Not Include All-Terrain Vehicles/Cycles)

- (80) Motorcycle
- (81) Moped (motorized bicycle)
- (82) Three-wheel motorcycle or moped
- (88) Other motored cycle (minibike, motorscooter) (specify): _____
- (89) Unknown motored cycle type

Other Vehicles

- (90) ATV (All-Terrain Vehicle) and ATC (All-Terrain Cycle)
- (91) Snowmobile
- (92) Farm equipment other than trucks
- (93) Construction equipment other than trucks
- (97) Other vehicle type
- (99) Unknown body type

VEHICLE WEIGHT ITEMS **RECONSTRUCTION DATA**

15. Vehicle Curb Weight 1.670
 Code weight to nearest 10 kilograms.
 (045) Less than 450 kilograms
 (610) 6,100 kilograms or more
 (999) Unknown

3.690 lbs X .4536 = 1.674 kgs

Source: _____

16. Vehicle Cargo Weight 9.990
 Code weight to nearest 10 kilograms.
 (000) Less than 5 kilograms
 (450) 4,500 kilograms or more
 (999) Unknown

_____, _____ lbs X .4536 = _____ kgs

18. Impact Speed + 999
 Nearest kmph

(NOTE: 000 means greater than .5 kmph)
 (160) 159.5 kmph and above
 (999) Unknown

19. Accuracy Range of Impact Speed Estimate 9
 (0) No reconstruction
 (1) Less than 2 kmph
 (2) ≥ 2 kmph and ≤ 8 kmph
 (3) ≥ 9 kmph and ≤ 16 kmph
 (4) ≥ 17 kmph and ≤ 26 kmph
 (9) Unknown

20. Data Source of Impact Speed 0
 (0) No impact speed calculated
 (1) Zone center calculation
 (2) Police calculation
 (3) Driver/witness/police estimates

OTHER DATA

17. Vehicle Special Use (This Trip) 0
 (0) No special use
 (1) Taxi
 (2) Vehicle used as school bus
 (3) Vehicle used as other bus
 (4) Military
 (5) Police
 (6) Ambulance
 (7) Fire truck or car
 (8) Other (specify): _____
 (9) Unknown

PRECRASH DATA

21. Driver's Attention to Driving 9
 (Prior to Recognition of Critical Event)
 (1) Full attention to driving
 (2) Distracted by other occupant
 (3) Distracted by moving object in vehicle
 (4) Distracted by outside person, object, or event
 (5) Talking on cellular phone or CB radio
 Specify: _____
 (6) Sleeping or dozing while driving
 (8) Other (specify): _____
 (9) Unknown

22. Pre-Event Vehicle Movement 01
 (Prior to Recognition of Critical Event)
 (01) Going straight
 (02) Slowing or stopping in traffic lane
 (03) Starting in traffic lane
 (04) Stopped in traffic lane
 (05) Passing or overtaking another vehicle
 (06) Disabled or parked in travel lane
 (07) Leaving a parking position
 (08) Entering a parking position
 (09) Turning right
 (10) Turning left
 (11) Making a U-turn
 (12) Backing up (other than for parking position)
 (13) Negotiating a curve
 (14) Changing lanes
 (15) Merging
 (16) Successful avoidance maneuver to a previous critical event
 (97) Other (specify): _____
 (98) No driver present
 (99) Unknown

STOP - VARIABLES 18 THROUGH 20 ARE COMPLETED BY THE ZONE CENTER

23. Critical Precrash Event 80*This Vehicle Loss of Control Due To:*

- (01) Blow out or flat tire
- (02) Stalled engine
- (03) Disabling vehicle failure (e.g., wheel fell off) (specify): _____
- (04) Non-disabling vehicle problem (e.g., hood flew up) (specify): _____
- (05) Poor road conditions (puddle, pot hole, ice, etc.) (specify): _____
- (06) Traveling too fast for conditions
- (08) Other cause of control loss (specify): _____

- (09) Unknown cause of control loss

This Vehicle Traveling

- (10) Over the lane line on left side of travel lane
- (11) Over the lane line on right side of travel lane
- (12) Off the edge of the road on the left side
- (13) Off the edge of the road on the right side
- (14) End departure
- (15) Turning left at intersection
- (16) Turning right at intersection
- (17) Crossing over (passing through) intersection
- (19) Unknown travel direction

Other Motor Vehicle In Lane

- (50) Stopped
- (51) Traveling in same direction with lower speed (i.e., lower steady speed or decelerating)
- (52) Traveling in same direction with higher speed
- (53) Traveling in opposite direction
- (54) In crossover
- (55) Backing
- (59) Unknown travel direction of other motor vehicle in lane

Other Motor Vehicle Encroaching Into Lane

- (60) From adjacent lane (same direction)—over left lane line
- (61) From adjacent lane (same direction)—over right lane line
- (62) From opposite direction—over left lane line
- (63) From opposite direction—over right lane line
- (64) From parking lane
- (65) From crossing street, turning into same direction
- (66) From crossing street, across path
- (67) From crossing street, turning into opposite direction
- (68) From crossing street, intended path not known
- (70) From driveway, turning into same direction
- (71) From driveway, across path
- (72) From driveway, turning into opposite direction
- (73) From driveway, intended path not known
- (74) From entrance to limited access highway
- (78) Encroachment by other vehicle—details unknown

Pedestrian or Pedalcyclist, or Other Nonmotorist

- (80) Pedestrian in roadway
- (81) Pedestrian approaching roadway
- (82) Pedestrian—unknown location

- (83) Pedalcyclist or other nonmotorist in roadway (specify): _____
- (84) Pedalcyclist or other nonmotorist approaching roadway (specify): _____
- (85) Pedalcyclist or other nonmotorist—unknown location (specify): _____

Object or Animal

- (87) Animal in roadway
- (88) Animal approaching roadway
- (89) Animal—unknown location
- (90) Object in roadway
- (91) Object approaching roadway
- (92) Object—unknown location
- (98) Other critical precrash event (specify): _____

- (99) Unknown

24. Attempted Avoidance Maneuver 99

- (00) No driver present
- (01) No avoidance actions *No Interview*
- (02) Braking (no lockup) *Data to support*
- (03) Braking (lockup) *0300 E.*
- (04) Braking (lockup unknown)
- (05) Releasing brakes
- (06) Steering left
- (07) Steering right
- (08) Braking and steering left
- (09) Braking and steering right
- (10) Accelerating
- (11) Accelerating and steering left
- (12) Accelerating and steering right
- (98) Other action (specify): _____
- (99) Unknown *Driver is present, Stability unknown*

25. Precrash Stability After Avoidance Maneuver 90

- (0) No driver present
- (1) No avoidance maneuver
- (2) Tracking
- (3) Skidding longitudinally—rotation less than 30 degrees
- (4) Skidding laterally—clockwise rotation
- (5) Skidding laterally—counterclockwise rotation
- (8) Other vehicle loss-of-control (specify): _____

- (9) Precrash stability unknown *Driver is present, consequences unknown.*

26. Precrash Directional Consequences of Avoidance Maneuver (Corrective Action) 90

- (0) No driver present
- (1) No avoidance maneuver
- (2) Vehicle stayed in travel lane where avoidance maneuver was initiated
- (3) Vehicle stayed on roadway but left travel lane where avoidance maneuver was initiated
- (4) Vehicle stayed on roadway, not known if left travel lane where avoidance maneuver was initiated
- (5) Vehicle departed roadway
- (6) Avoidance maneuver initiated off roadway
- (9) Directional consequences unknown

ENVIRONMENTAL DATA

<p>27. Relation to Junction <u>2</u></p> <p>(0) Non-junction (1) Interchange area</p> <p><i>Non-Interchange</i></p> <p>(2) Intersection (3) Intersection-related (4) Drive, alley access related (5) Other non-interchange (specify): _____</p> <p>(6) <u>Unknown type of non-interchange</u> (9) Unknown if interchange</p>	<p>33. Roadway Surface Condition <u>2</u></p> <p>(1) Dry (2) Wet (3) Snow and slush (4) Ice (5) Sand, dirt or oil (8) Other (specify): _____ (9) Unknown</p>
<p>28. Trafficway Flow <u>1</u></p> <p>(1) Not physically divided (two way traffic) (2) Divided trafficway - median strip without positive barrier (3) Divided trafficway - median strip with positive barrier (4) One way trafficway (9) Unknown</p>	<p>34. Traffic Control Device <u>0</u></p> <p>(0) No traffic control(s) (1) Trafficway traffic control signal (not RR crossing)</p> <p><i>Regulatory or School Zone Sign (Not RR Crossing)</i></p> <p>(2) Stop sign (3) Yield sign (4) School zone sign (5) Other sign (specify): _____</p> <p>(6) <u>Unknown sign</u> (7) Warning sign (not RR crossing) (8) Miscellaneous/other controls including RR controls (specify): _____ (9) Unknown</p>
<p>29. Number of Travel Lanes <u>4</u></p> <p>(1) One (2) Two (3) Three (4) Four (5) Five (6) Six (7) Seven or more (9) Unknown</p>	<p>35. Traffic Control Device Functioning <u>0</u></p> <p>(0) No traffic control (1) Not Functioning (2) Functioning (9) Unknown</p>
<p>30. Roadway Alignment <u>1</u></p> <p>(1) Straight (2) Curve right (3) Curve left (9) Unknown</p>	<p>36. Light Conditions <u>3</u></p> <p>(1) Daylight (2) Dark (3) Dark, but lighted (4) Dawn (5) Dusk (9) Unknown</p>
<p>31. Roadway Profile <u>1</u></p> <p>(1) Level (2) Uphill Grade (> 2%) (3) Downhill Grade (> 2%) (4) Hillcrest (5) Sag (9) Unknown</p>	<p>37. Atmospheric Conditions <u>2</u></p> <p>(1) No adverse atmospheric related driving conditions (2) Rain (3) Sleet (4) Snow (5) Fog (6) Rain and fog (7) Sleet and fog (8) Other (e.g., smog, smoke, blowing sand or dust, etc.) (specify): _____ (9) Unknown</p>
<p>32. Roadway Surface Type <u>2</u></p> <p>(1) Concrete (2) Bituminous (asphalt) (3) Brick or Block (4) Slag, gravel or stone (5) Dirt (8) Other (specify): _____ (9) Unknown</p>	



1. Primary Sampling Unit Number	<u>40</u>	3. Vehicle Number	<u>0 1</u>
2. Case Number - Stratum	<u>6 04 P</u> <u>AH</u>		

VEHICLE IDENTIFICATION

VIN 1FMCU24X1T4 Model Year 96

Vehicle Make (specify): FORD Vehicle Model (specify): EXPLORER

PEDESTRIAN FRONT CONTACT WORK SHEET

PEV06 Hood Material	<u>STEEL</u>
PEV08 Hood Length	<u>111</u> cm
PEV09 Hood Width-Forward Opening	<u>143</u> cm
PEV10 Hood Width-Midway	<u>145</u> cm
PEV11 Hood Width-Rear Opening	<u>145</u> cm
PEV14 Front Bumper Cover Material	<u>PLASTIC</u>
PEV15 Front Bumper Reinforcement Material	<u>STEEL</u>

VERTICAL MEASUREMENTS

PEV16 Front Bumper-Bottom Height	<u>50</u> cm
PEV17 Front Bumper-Top Height	<u>68</u> cm
PEV18 Forward Hood Opening	<u>98</u> cm
PEV19 Front Bumper Lead	<u>7</u> cm

WRAP DISTANCES

PEV20 Ground to Forward Hood Opening	<u>100</u> cm
PEV21 Ground to Front/Top Transition Point	<u>108</u> cm
PEV22 Ground to Rear Hood Opening	<u>208</u> cm
PEV23 Ground to Base of Windshield	<u>220</u> cm
PEV24 Ground to Top of Windshield	<u>291</u> cm
PEV25 Ground to Head Contact	<u>999</u> cm

page 13

VEHICLE DAMAGE SKETCH

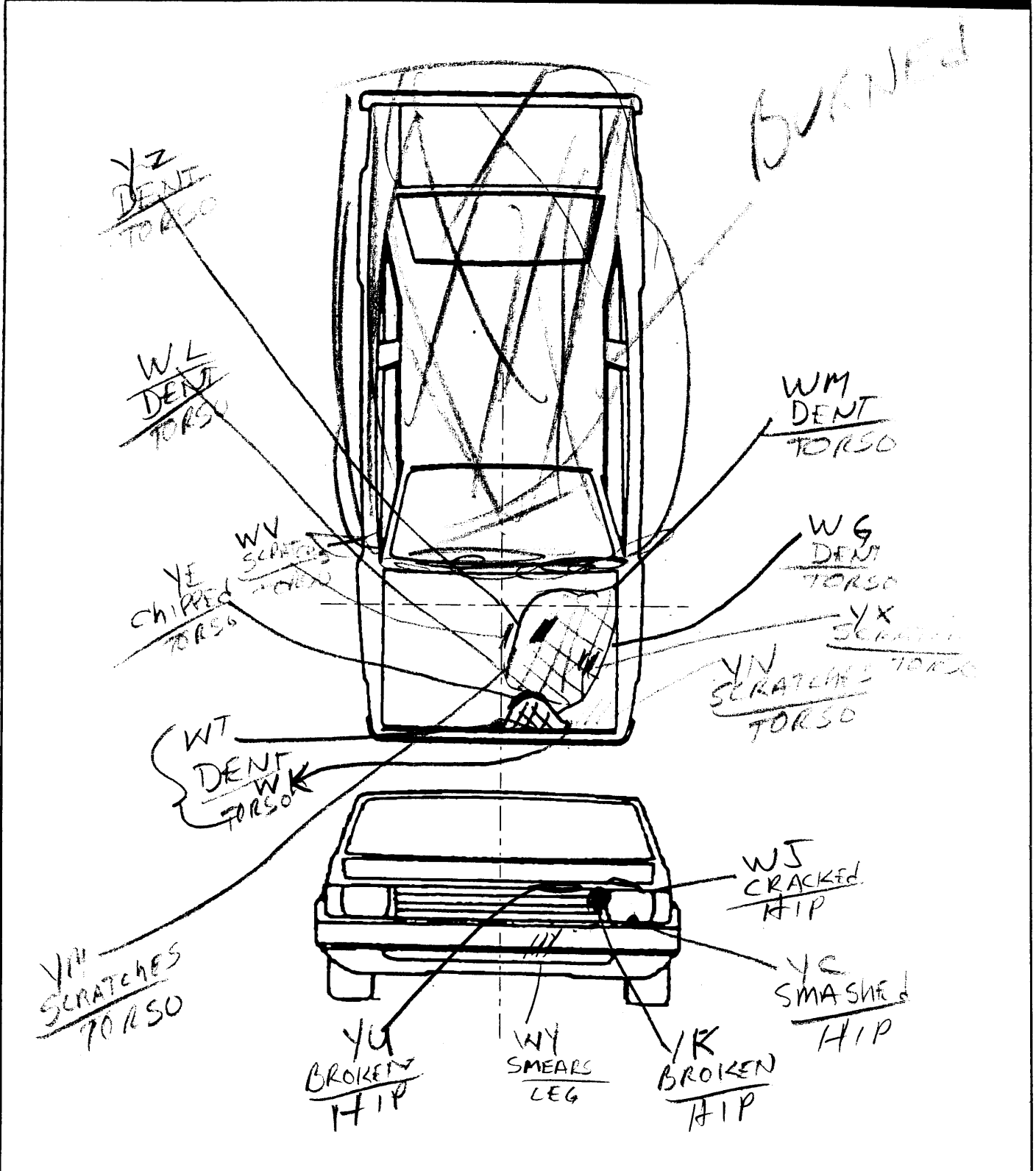

NOTES: Sketch all pedestrian contacts, include the size and depth in centimeters. Locate the pedestrian contacts from the intercept point of the centerline (lateral) and the front axes (longitudinal) in centimeters. Annotate observations which might be useful in reconstructing the accident (e.g., grass in tire bead, direction of striations, scuff on sidewalls, etc.).

Location of the origin (intercept point of the centerline and the front axes) from the ground: 173 cm

PEDESTRIAN SIDE CONTACT WORK SHEET

PEV06 Hood Material _____

PEV08 Hood Length _____ cm

PEV09 Hood Width-Forward Opening _____ cm

PEV10 Hood Width-Midway _____ cm

PEV11 Hood Width-Rear Opening _____ cm

VERTICAL MEASUREMENTS

PEV26 Ground Clearance _____ cm

PEV27 Side Bumper-Bottom Height _____ cm

PEV28 Side Bumper-Top Height _____ cm

PEV29 Centerline of Wheel _____ cm

PEV30 Top of Tire _____ cm

PEV31 Top of Wheel Well Opening _____ cm

PEV32 Bottom of A-Pillar at Windshield _____ cm

PEV33 Top of A-Pillar at Windshield _____ cm

PEV34 Top of Side View Mirror _____ cm

LATERAL MEASUREMENTS

PEV35 C_L to A-Pillar at Bottom of Windshield _____ cm

PEV36 C_L to A-Pillar at Top of Windshield _____ cm

PEV37 C_L to Maximum Side View Mirror Protrusion _____ cm

WRAP DISTANCES

PEV38 Ground to Side/Top Transition _____ cm

PEV39 Ground to Hood Edge _____ cm

PEV40 Ground to Centerline of Hood (ORIGIN) _____ cm

PEV41 Ground to Head Contact _____ cm

VEHICLE DAMAGE SKETCH

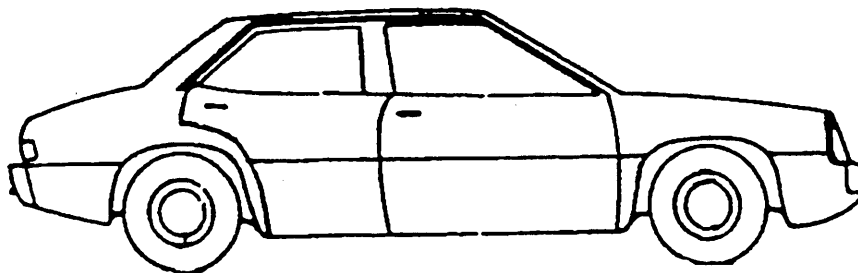
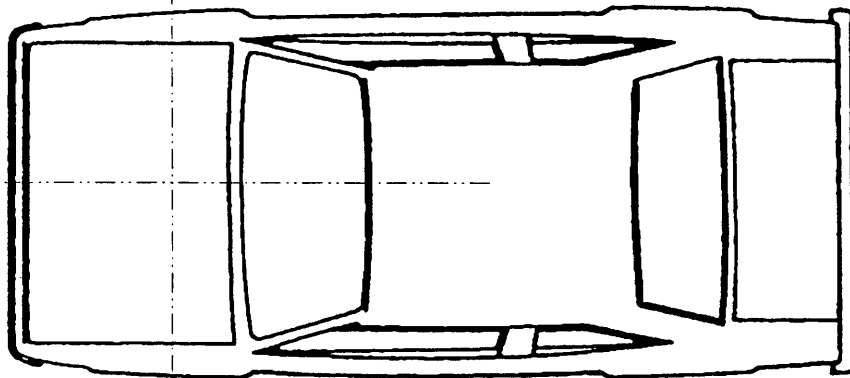
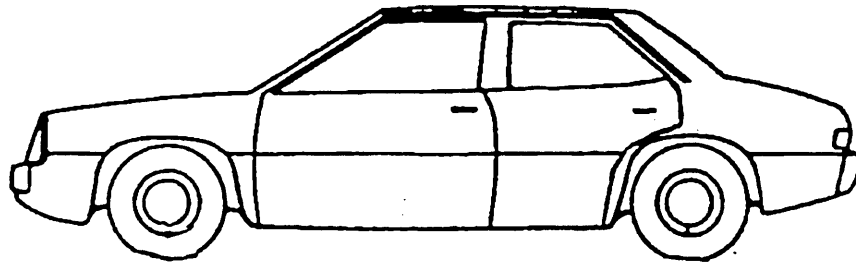

NOTES: Sketch all pedestrian contacts, include the size and depth in centimeters. Locate the pedestrian contacts from the intercept point of the centerline (lateral) and the front axles (longitudinal) in centimeters. Annotate observations which might be useful in reconstructing the accident (e.g., grass in tire bead, direction of striations, scuff on sidewalls, etc.).

Location of the origin (intercept point of the centerline and the front axles) from the ground: _____ cm

ORIGINAL SPECIFICATIONS

Wheelbase	<u>101.7</u>	inches	x 2.54 =	<u>258</u>	cm
Overall Length	<u>178.5</u>	inches	x 2.54 =	<u>453</u>	cm
Maximum Width	<u>68.2</u>	inches	x 2.54 =	<u>173</u>	cm
Curb Weight	<u>3690</u>	pounds	x .4536 =	<u>1674</u>	kg
Average Track	<u>58.8</u>	inches	x 2.54 =	<u>149</u>	cm
Front Overhang	<u>33.8</u>	inches	x 2.54 =	<u>86</u>	cm
Rear Overhang	<u>42.8</u>	inches	x 2.54 =	<u>108</u>	cm
Undeformed End Width	___	inches	x 2.54 =	___	cm
Engine Size: cyl./displ.	___	cc	x .001 =	<u>4.0</u>	L
	___	CID	x .0164 =	___	L

INJURY SOURCE

FRONT

- 700 Front bumper
- 701 Front lower valance/spoiler
- 702 Front grille
- 703 Hood edge and/or trim
- 704 Hood ornament (fixed)
- 705 Hood ornament (spring loaded)
- 706 Headlight
- 707 Retractable headlight door (Open/Closed)
- 708 Turn signal/parking lights
- 718 Other front or add on object
(specify): _____
- 719 Unknown front object

Left Side Components

- 720 Front fender side surface
- 721 Front antenna
- 722 A1 pillar
- 723 A2 pillar
- 724 B pillar
- 725 C pillar
- 726 D pillar
- 728 Other pillar
(specify): _____
- 729 Left side roof rail
- 730 Left side door surface
- 731 Left side door handle
- 732 Left side mirror fixed housing
- 733 Left side folding mirror
- 734 Left side glazing forward of B pillar
- 735 Left side glazing rearward of B pillar
- 736 Left side back fender or quarter panel
- 737 Rear antenna
- 738 Other left side object
(specify): _____
- 739 Unknown left side component

Right Side Components

- 740 Front fender side surface
- 741 Front antenna
- 742 A1 pillar
- 743 A2 pillar

- 744 B pillar
- 745 C pillar
- 746 D pillar
- 748 Other pillar (specify): _____
- 749 Right side roof rail
- 750 Right side door surface
- 751 Right side door handle
- 752 Right side mirror fixed housing
- 753 Right side folding mirror
- 754 Right side glazing forward of B pillar
- 755 Right side glazing rearward of B pillar
- 756 Rear antenna
- 757 Rear fender or quarter panel
- 758 Other right side object
(specify): _____
- 759 Unknown right side component

Back Components

- 760 Rear (back) bumper
- 761 Tailgate
- 762 Hatchback, vertical surface
- 768 Other back component
(specify): _____
- 769 Unknown back component

Top Components

- 770 Hood surface
- 771 Hood surface reinforced by under hood component
- 772 Front fender top surface
- 773 Cowl area
- 774 Wiper blade & mountings
- 775 Windshield glazing
- 776 Front header
- 777 Roof surface
- 778 Backlight glazing
- 779 Rear header
- 780 Hatchback
- 781 Rear trunk lid
- 788 Other top component (specify): _____
- 789 Unknown top component

Wheels / tires

- 790 Left front wheel / tire
- 791 Right front wheel / tire
- 792 Left rear wheel / tire
- 793 Right rear wheel / tire
- 798 Other wheel / tire (specify): _____
- 799 Unknown wheel / tire

Undercarriage components

- 800 Front cross member
- 801 Steering assembly/Front suspension
- 802 Oil pan
- 803 Exhaust system pipe
- 804 Transmission
- 805 Drive shaft
- 806 Catalytic converter
- 807 Muffler
- 808 Floor pan
- 809 Fuel tank
- 810 Rear suspension
- 818 Other undercarriage component
(specify): _____
- 819 Unknown undercarriage component

Accessories

- 820 Air scoop, deflector
- 821 Cellular or CB radio antenna
- 822 Emergency lights or bar
- 823 Fog lights
- 824 Luggage, ski, or bike rack
- 825 Cargo (specify): _____
- 826 Spare tire
- 827 Spotlight
- 828 Other accessory (specify): _____

Other Object or Vehicle in Environment

- 947 Ground
- 948 Other object (specify): _____
- 949 Unknown object in environment
- 959 Unknown object on contacting vehicle
- 997 Noncontact injury source
- 999 Unknown injury source

VEHICLE DIMENSIONS

4. Original Wheelbase 258
 _____ Code to the
 nearest centimeter
 (999) Unknown

201.7 inches X 2.54 = 258 centimeters

5. Original Average Track Width 149
 _____ Code to the
 nearest centimeter
 (185) 185 centimeters or more
 (999) Unknown

58.8 inches X 2.54 = 149 centimeters

6. Hood Material 3
 (1) Plastic
 (2) Fiberglass
 (3) Steel
 (4) Aluminum
 (5) Stainless Steel
 (8) Other (specify): _____
 (9) Unknown

7. Hood Original 1
 Equipment Manufacturer (OEM)
 (1) OEM factory installed hood
 (2) OEM replacement
 (3) Non-OEM replacement
 (9) Unknown

8. Hood Length 111
 _____ Code to the
 nearest centimeter
 (180) 180 centimeters or more
 (999) Unknown

43.7 inches X 2.54 = 111 centimeter

9. Hood Width Forward Opening 143
 _____ Code to the
 nearest centimeter
 (210) 210 centimeters or more
 (999) Unknown

56.3 inches X 2.54 = 143 centimeters

10. Hood Width Midway 145
 _____ Code to the
 nearest centimeter
 (210) 210 centimeters or more
 (999) Unknown

57.0 inches X 2.54 = 145 centimeters

11. Hood Width Rear Opening 145
 _____ Code to the
 nearest centimeter
 (210) 210 centimeters or more
 (999) Unknown

57.0 inches X 2.54 = 145 centimeters

12. Hood/Fender Vertical/Lateral Crush From Pedestrian 2
 (0) Not damaged
 (1) Surface scratching only, no residual crush
 (2) Minor crush (1-3 centimeters)
 (3) Moderate crush (4-7 centimeters)
 (4) Severe crush (>7 centimeters)
 (8) Damage present, unknown if damage is from pedestrian impact
 (9) Unknown

13. Windshield Contact Damage From Pedestrian Contact 9
 (0) Not contacted by pedestrian
 (1) Contacted by pedestrian - not damaged
 (2) Contacted by pedestrian - damaged
 (3) Unknown if contacted by pedestrian - not damaged
 (4) Unknown if contacted by pedestrian - damaged
 (9) Unknown if contacted by pedestrian - unknown if damaged

FRONT CONTACT DAMAGE**Front Vertical Measurements**

14. Front Bumper Cover Material 1
 (0) No front contact
 (1) Plastic
 (2) Fiberglass
 (3) Rubber
 (4) Other (specify): _____
 (9) Unknown

15. Front Bumper Reinforcement Material 1
 (0) No front contact
 (1) Steel
 (2) Aluminum
 (3) Stainless Steel
 (4) Other (specify): _____
 (9) Unknown

16. Front Bumper-Bottom Height 050
 _____ Code to the
 nearest centimeter
 (000) No front contact
 (150) 150 centimeters or more
 (999) Unknown

19.7 inches X 2.54 = 50 centimeters

17. Front Bumper-Top Height 068
 Code to the nearest centimeter
 (000) No front contact
 (150) 150 centimeters or more
 (999) Unknown
26.8 inches X 2.54 = 68 centimeters

18. Forward Hood Opening 098
 Code to the nearest centimeter
 (000) No front contact
 (200) 200 centimeters or more
 (999) Unknown
38.6 inches X 2.54 = 98 centimeters

19. Front Bumper Lead 07
 (00) No front contact
 Code to the nearest centimeter
 (30) 30 centimeters or more
 (99) Unknown
2.8 inches X 2.54 = 7 centimeters

23. Ground to Base of Windshield 220
 Code to the nearest centimeter
 (000) No front contact
 (400) 400 centimeters or more
 (999) Unknown
86.6 inches X 2.54 = 220 centimeters

24. Ground to Top of Windshield 291
 Code to the nearest centimeter
 (000) No front contact
 (500) 500 centimeters or more
 (999) Unknown
114.6 inches X 2.54 = 291 centimeters

25. Ground To Head Contact 999
 Code to the nearest centimeter
 (000) No front contact
 (400) 400 centimeters or more
 (998) No head contact
 (999) Unknown
 _____ inches X 2.54 = _____ centimeters

Front Wrap Distance Measurements

SIDE CONTACT DAMAGE

20. Ground to Forward Hood Opening 100
 Code to the nearest centimeter
 (000) No front contact
 (200) 200 centimeters or more
 (999) Unknown
39.4 inches X 2.54 = 100 centimeters

21. Ground to Front/Top Transition Point 108
 Code to the nearest centimeter
 (000) No front contact
 (180) 180 centimeters or more
 (999) Unknown
42.5 inches X 2.54 = 108 centimeters

22. Ground to Rear Hood Opening 208
 Code to the nearest centimeter
 (000) No front contact
 (400) 400 centimeters or more
 (999) Unknown
81.9 inches X 2.54 = 208 centimeters

Side Vertical Measurements

26. Ground Clearance 000
 Code to the nearest centimeter
 (000) No side contact
 (150) 150 centimeters or more
 (999) Unknown
 _____ inches X 2.54 = _____ centimeters

27. Side Bumper-Bottom Height 000
 Code to the nearest centimeter
 (000) No side contact
 (150) 150 centimeters or more
 (999) Unknown
 _____ inches X 2.54 = _____ centimeters

28. Side Bumper-Top Height 000
 Code to the nearest centimeter
 (000) No side contact
 (150) 150 centimeters or more
 (999) Unknown
 _____ inches X 2.54 = _____ centimeters

29. Centerline of Wheel 
 _____ Code to the
 nearest centimeter
 (000) No side contact
 (150) 150 centimeters or more
 (999) Unknown
 _____ . ____ inches X 2.54 = _____ centimeters

30. Top of Tire 
 _____ Code to the
 nearest centimeter
 (000) No side contact
 (200) 200 centimeters or more
 (999) Unknown
 _____ . ____ inches X 2.54 = _____ centimeters

31. Top of Wheel Well Opening 
 _____ Code to the
 nearest centimeter
 (000) No side contact
 (250) 250 centimeters or more
 (999) Unknown
 _____ . ____ inches X 2.54 = _____ centimeters

32. Bottom of A-Pillar at Windshield 
 _____ Code to the
 nearest centimeter
 (000) No side contact
 (250) 250 centimeters or more
 (999) Unknown
 _____ . ____ inches X 2.54 = _____ centimeters

33. Top of A-Pillar at Windshield 
 _____ Code to the
 nearest centimeter
 (000) No side contact
 (300) 300 centimeters or more
 (999) Unknown
 _____ . ____ inches X 2.54 = _____ centimeters

34. Top of Side View Mirror 
 _____ Code to the
 nearest centimeter
 (000) No side contact
 (300) 300 centimeters or more
 (999) Unknown
 _____ . ____ inches X 2.54 = _____ centimeters

Side Lateral Measurements

35. Centerline to A-Pillar at Bottom of Windshield 
 _____ Code to the
 nearest centimeter
 (000) No side contact
 (250) 250 centimeters or more
 (999) Unknown
 _____ . ____ inches X 2.54 = _____ centimeters

36. Centerline to A-Pillar at Top of Windshield 
 _____ Code to the
 nearest centimeter
 (000) No side contact
 (250) 250 centimeters or more
 (999) Unknown
 _____ . ____ inches X 2.54 = _____ centimeter

37. Centerline to Maximum Side View Mirror Protrusion 
 _____ Code to the
 nearest centimeter
 (000) No side contact
 (300) 300 centimeters or more
 (999) Unknown
 _____ . ____ inches X 2.54 = _____ centimeter

Side Wrap Distance Measurements

38. Ground to Side/Top Transition 
 _____ Code to the
 nearest centimeter
 (000) No side contact
 (400) 400 centimeters or more
 (999) Unknown
 _____ . ____ inches X 2.54 = _____ centimeters

39. Ground to Hood Edge 
 _____ Code to the
 nearest centimeter
 (000) No side contact
 (500) 500 centimeters or more
 (999) Unknown
 _____ . ____ inches X 2.54 = _____ centimeters

40. Ground to Centerline of Hood

000

Code to the nearest centimeter

- (000) No side contact
- (700) 700 centimeters or more
- (999) Unknown

_____ . ____ inches X 2.54 = _____ centimeters

41. Ground to Head Contact

000

Code to the nearest centimeter

- (000) No side contact
- (800) 800 centimeters or more
- (998) No head contact
- (999) Unknown

_____ . ____ inches X 2.54 = _____ centimeters

PEDESTRIAN ASSESSMENT FORM

1. Primary Sampling Unit Number. 40

2. Case Number - Stratum 604P
217

3. Pedestrian Number 01

10. Pedestrian's Weight 073
Code actual weight to the nearest
kilogram.

(999) Unknown
161 pounds X .4536 = 73 kilograms

PEDESTRIAN'S CHARACTERISTICS

PEDESTRIAN'S PRE-AVOIDANCE ACTIONS

4. Pedestrian's Age 72
Code actual age at time of accident.
(00) Less than one year old (specify by month):

(97) 97 years and older
(99) Unknown

5. Pedestrian's Sex 1
(1) Male

(2) Female - not reported pregnant
(3) Female - pregnant-1st trimester (1st-3rd month)
(4) Female - pregnant-2nd trimester (4th-6th month)
(5) Female - pregnant-3rd trimester (7th-9th month)
(6) Female - pregnant-term unknown
(9) Unknown

6. Pedestrian's Overall Height 170
Code actual height to the nearest
centimeter.
(999) Unknown
67 inches X 2.54 = 170 centimeters

7. Pedestrian's Height - Ground to Knee 99
Code to the nearest
centimeter.
(999) Unknown
_____ inches X 2.54 = _____ centimeters

8. Pedestrian's Height - Ground to Hip 999
Code to the nearest
centimeter.
(999) Unknown
_____ inches X 2.54 = _____ centimeters

9. Pedestrian's Height - Ground to Shoulder 999
Code to the nearest
centimeter.
(999) Unknown
_____ inches X 2.54 = _____ centimeters

11. Pedestrian Attitude 1
(1) Standing

(2) Crouching
(3) Kneeling
(4) Bending at waist
(8) Other (specify): _____
(9) Unknown

12. Pedestrian Motion 1
(0) Not moving

(1) Walking slowly
(2) Walking rapidly
(3) Running or jogging
(4) Hopping
(5) Skipping
(6) Jumping
(7) Falling/stumbling or rising
(8) Other (specify): _____
(9) Unknown

13. Pedestrian's Action Relative to Vehicle 01
(00) Stopped

(01) Crossing road, straight
(02) Crossing road, diagonally
(03) Moving in road, with traffic
(04) Moving in road, against traffic
(05) Off road, approaching road
(06) Off road, going away from road
(07) Off road, moving parallel
(08) Off road, crossing driveway
(09) Off road, moving along driveway
(98) Other (specify): _____
(99) Unknown

14. Pedestrian's Body (Chest) Orientation
Relative to Striking Vehicle Prior to
Avoidance Actions 7

(1) Facing vehicle
(2) Facing away
(3) Left side to vehicle
(4) Right side to vehicle
(8) Other (specify): _____
(9) Unknown

HS Form 435H (7/95) This report is authorized by P.L. 89-563, Title 1, Section 106, 108, and 112. While you are not required to respond, your cooperation is needed to make the results of this data collection effort comprehensive, accurate and timely.

PEDESTRIAN'S AVOIDANCE ACTIONS15. Pedestrian's First Avoidance Actions 99

- (00) No avoidance actions
- (01) Stopped
- (02) Accelerated pace
- (03) Ran away (along vehicle path)
- (04) Jumped
- (05) Turned toward vehicle
- (06) Turned away from vehicle
- (07) Dove or fell away

Used hand(s) to :

- (11) Vault corner of vehicle
- (12) Vault onto vehicle
- (13) Brace against vehicle
- (14) Crouched and braced hands against vehicle
- (98) Other (specify): _____
- (99) Unknown

PEDESTRIAN'S ORIENTATION AT IMPACT16. Pedestrian's Head Orientation at Initial Impact 9

- (1) To front
- (2) To left
- (3) To right
- (4) Up
- (5) Down
- (8) Other (specify): _____
- (9) Unknown

17. Pedestrian's Body (Chest) Orientation at Initial Impact 9

- (1) Facing vehicle
- (2) Facing away
- (3) Left side to vehicle
- (4) Right side to vehicle
- (8) Other (specify): _____
- (9) Unknown

18. Pedestrian's Arm Orientation at Initial Impact 09

- (01) At sides
- (02) Folded across chest
- (03) Hands clasped behind back
- (04) Hands on hips
- (05) Hands in pockets

One or both arms:

- (06) Extended upward
- (07) Extended to side
- (08) Extended forward bracing
- (09) Extended, holding object (briefcase, suitcase, etc.) *CANE*
- (10) Holding object (young child, grocery bag, etc.) in arm(s)
- (11) Holding object (young child, grocery bag, etc.) on shoulder(s) or head
- (98) Other (specify): _____
- (99) Unknown

19. Pedestrian's Leg Orientation at Initial Impact 99

- (01) Together
- (02) Apart-laterally
- (03) Apart-right leg forward
- (04) Apart-left leg forward
- (05) Apart- forward leg unknown
- (06) Left foot off the ground
- (07) Right foot off the ground
- (08) Both feet off the ground
- (98) Other (specify): _____
- (99) Unknown

20. Vehicle/Pedestrian's Interaction 02

- (01) Carried by vehicle, wrapped position
- (02) Carried by vehicle, slid to windshield
- (03) Carried by vehicle, position unknown
- (04) Passed over vehicle top
- (05) Thrown straight forward
- (06) Thrown forward and left of vehicle
- (07) Thrown forward and right of vehicle
- (08) Knocked to pavement, forward
- (09) Knocked to pavement, left of vehicle
- (10) Knocked to pavement, right of vehicle
- (11) Knocked to pavement, run over or dragged by vehicle
- (12) Shunted to left (corner impacts only)
- (13) Shunted to right (corner impacts only)
- (14) Bumped or pushed aside
- (15) Snagged, rotated
- (16) Snagged, dragged by vehicle
- (17) Foot or legs run over
- (98) Other (specify): _____
- (99) Unknown

OFFICIAL RECORDS

INJURY CONSEQUENCES

21. Police Reported Alcohol Presence
For Pedestrian

- (0) No alcohol present
(1) Yes alcohol present
(7) Not reported
(9) Unknown

0

22. Alcohol Test Result For Pedestrian
Code actual value (decimal implied
before first digit—0.xx)

- (95) Test refused
(96) None given
(97) AC (Alcohol Content)
test performed, results unknown
(99) Unknown if test given

.05

Source: AUTOPSY

23. Police Reported Other Drug Presence
For Pedestrian

- (0) No other drug(s) present
(1) Yes other drug(s) present
(7) Not reported
(9) Unknown

0

24. Other Drug Specimen Test Result
For Pedestrian

- (0) No specimen test given
(1) Drug not found in specimen
(2) Drug found in specimen,
(specify): _____
(3) Specimen test given,
results unknown or not obtained
(9) Unknown

1

25. Injury Severity (Police Rating)

- (0) O - No injury
(1) C - Possible injury
(2) B - Nonincapacitating injury
(3) A - Incapacitating injury
(4) K - Killed
(5) U - Injury, severity unknown
(6) Died prior to accident
(9) Unknown

4

26. Treatment - Mortality

- (0) No treatment
(1) Fatal
(2) Fatal - ruled disease (specify):

1

Nonfatal

- (3) Hospitalization
(4) Transported and released
(5) Treatment at scene - non-transported
(6) Treatment later
(8) Treatment - other (specify):

(9) Unknown

27. Type Of Medical Facility
(for Initial Treatment)

- (0) Not treated at a medical facility
(1) Trauma center
(2) Hospital
(3) Medical clinic
(4) Physician's office
(5) Treatment later at medical facility
(8) Other (specify): _____
(9) Unknown

1

28. Hospital Stay

- (00) Not Hospitalized
_____ Code the number of days (up through 60)
that the pedestrian stayed in a hospital.
(61) 61 days or more
(99) Unknown

00

29. Working Days Lost

- _____ Code the number of days
(up through 60) that the pedestrian
lost from work due to the accident
(00) No working days lost
(61) 61 days or more
(62) Fatally injured
(97) Not working prior to accident
(99) Unknown

62

STOP - VARIABLES 30 THROUGH 37 ARE COMPLETED BY THE ZONE CENTER

30. Glasgow Coma Scale (GCS) Score 01
 (at Medical Facility)
 (00) Not injured
 (01) Injured - not treated at medical facility
 (02) No GCS Score at medical facility
 (03-15) Code the actual value of the initial GCS Score recorded at medical facility.
 (97) Injured, details unknown
 (99) Unknown if injured

31. Was the Pedestrian Given Blood? 1
 (1) No - blood not given
 (2) Yes - blood given
 (specify units): _____
 (9) Unknown if blood given

32. Arterial Blood Gases (ABG) - HCO₃ 01
 (00) Not injured
 (01) Injured, ABGs not measured or reported
 (02-50) Code the actual value of the HCO₃
 (96) ABGs reported, HCO₃ unknown
 (97) Injured, details unknown
 (99) Unknown if injured

33. Time to Death 99
 _____ Code number of hours from time of accident to time of death up through 24 hours. If time of death is greater than 24 hours, code number of days. (Note: 1 day = 31, 2 days = 32, ... n days = 30 + n up through 30 days = 60)
 (00) Not fatal
 (96) Fatal - ruled disease
 (99) Unknown

34. 1st Medically Reported Cause of Death 12

35. 2nd Medically Reported Cause of Death 13

36. 3rd Medically Reported Cause of Death 11

_____ Code the Pedestrian Injury from line number(s) for the medically reported injury(s) which reportedly contributed to this pedestrian's death
 (00) Not fatal or no additional causes
 (96) Mode of death given but specific injuries are not linked to cause of death. (specify): _____

(97) Other result (includes fatal ruled disease) (specify): _____

(99) Unknown

37. Number of Recorded Injuries for This Pedestrian 17

_____ Code the actual number of injuries recorded for this pedestrian.
 (00) No recorded injuries
 (97) Injured, details unknown
 (99) Unknown if injured

ARE ALL APPLICABLE MEDICAL RECORDS INCLUDED WITH INITIAL SUBMISSION?

NO YES

UPDATE CANDIDATE? NO YES



PEDESTRIAN INJURY FORM

1. Primary Sampling Unit Number 40

3. Pedestrian Number 01

2. Case Number - Stratum 6 04 P
AT

4. Blank X X

INJURY DATA

Record below the actual injuries sustained by this pedestrian in CHRONOLOGICAL order that were identified from the official and unofficial data sources. Remember not to double count an injury just because it was identified from two different sources. If greater than twenty-five injuries have been documented, encode the balance on the Pedestrian Injury Supplement.

Source of Injury Data	Body Region	Type of Anatomic Structure	AIS-90			A.I.S. Severity	Aspect	Injury Source	Injury Confidence Level	Direct/ Indirect Injury	Striking Profile	Type Of Damage	Damage Depth
			Specific Anatomic Structure	Level of Injury									
<i>back of head</i>	5. <u>1</u>	6. <u>1</u>	7. <u>9</u>	8. <u>06</u>	9. <u>02</u>	10. <u>1</u>	11. <u>6</u>	12. <u>770</u>	13. <u>2</u>	14. <u>1</u>	15. <u>2</u>	16. <u>3</u>	17. <u>4</u>
<i>source - missing teeth</i>	18. <u>1</u>	19. <u>2</u>	20. <u>5</u>	21. <u>14</u>	22. <u>06</u>	23. <u>1</u>	24. <u>8</u>	25. <u>770</u>	26. <u>2</u>	27. <u>1</u>	28. <u>2</u>	29. <u>3</u>	30. <u>4</u>
<i>supra pubic</i>	31. <u>1</u>	32. <u>8</u>	33. <u>5</u>	34. <u>26</u>	35. <u>00</u>	36. <u>2</u>	37. <u>5</u>	38. <u>702</u>	39. <u>1</u>	40. <u>1</u>	41. <u>2</u>	42. <u>5</u>	43. <u>2</u>
<i>source - pubic</i>	44. <u>1</u>	45. <u>8</u>	46. <u>5</u>	47. <u>28</u>	48. <u>00</u>	49. <u>3</u>	50. <u>6</u>	51. <u>702</u>	52. <u>1</u>	53. <u>1</u>	54. <u>2</u>	55. <u>5</u>	56. <u>2</u>
<i>source - pubic</i>	57. <u>1</u>	58. <u>8</u>	59. <u>5</u>	60. <u>34</u>	61. <u>22</u>	62. <u>3</u>	63. <u>1</u>	64. <u>700</u>	65. <u>1</u>	66. <u>1</u>	67. <u>1</u>	68. <u>2</u>	69. <u>2</u>
<i>source - pubic</i>	70. <u>1</u>	71. <u>8</u>	72. <u>5</u>	73. <u>16</u>	74. <u>06</u>	75. <u>2</u>	76. <u>1</u>	77. <u>700</u>	78. <u>1</u>	79. <u>1</u>	80. <u>1</u>	81. <u>2</u>	82. <u>2</u>
<i>source - pubic</i>	83. <u>1</u>	84. <u>6</u>	85. <u>5</u>	86. <u>04</u>	87. <u>16</u>	88. <u>2</u>	89. <u>7</u>	90. <u>770</u>	91. <u>1</u>	92. <u>1</u>	93. <u>2</u>	94. <u>3</u>	95. <u>4</u>
<i>source - pubic</i>	96. <u>1</u>	97. <u>6</u>	98. <u>5</u>	99. <u>02</u>	100. <u>16</u>	101. <u>2</u>	102. <u>6</u>	103. <u>770</u>	104. <u>2</u>	105. <u>1</u>	106. <u>2</u>	107. <u>3</u>	108. <u>4</u>
<i>source - pubic</i>	109. <u>1</u>	110. <u>6</u>	111. <u>5</u>	112. <u>02</u>	113. <u>08</u>	114. <u>2</u>	115. <u>6</u>	116. <u>770</u>	117. <u>2</u>	118. <u>1</u>	119. <u>2</u>	120. <u>3</u>	121. <u>4</u>
<i>source - pubic</i>	122. <u>1</u>	123. <u>1</u>	124. <u>4</u>	125. <u>04</u>	126. <u>66</u>	127. <u>3</u>	128. <u>6</u>	129. <u>770</u>	130. <u>2</u>	131. <u>1</u>	132. <u>2</u>	133. <u>3</u>	134. <u>4</u>

OFFICIAL INJURY DATA — SOFT TISSUE INJURIES

Indicate the Location, Specific Anatomic Structure, Detail (size, depth, fracture type, head injury clinical signs and neurological deficits), and Source of all injuries indicated by official sources (or from PAR or other unofficial sources if medical records and interviewee data are unavailable.)

PT PROUNCHED @ 23:25 2/28/98

RUT:
STELLATE BURSTING
TYPE LACERATIONS
"BACK OF HEAD"
MEASURE UP TO 3"
MAXIMUM

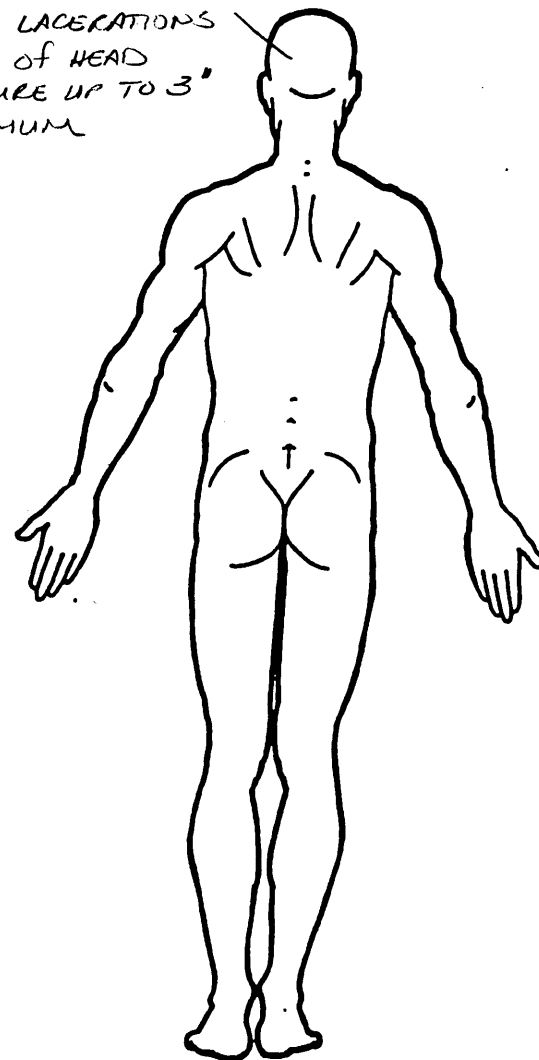
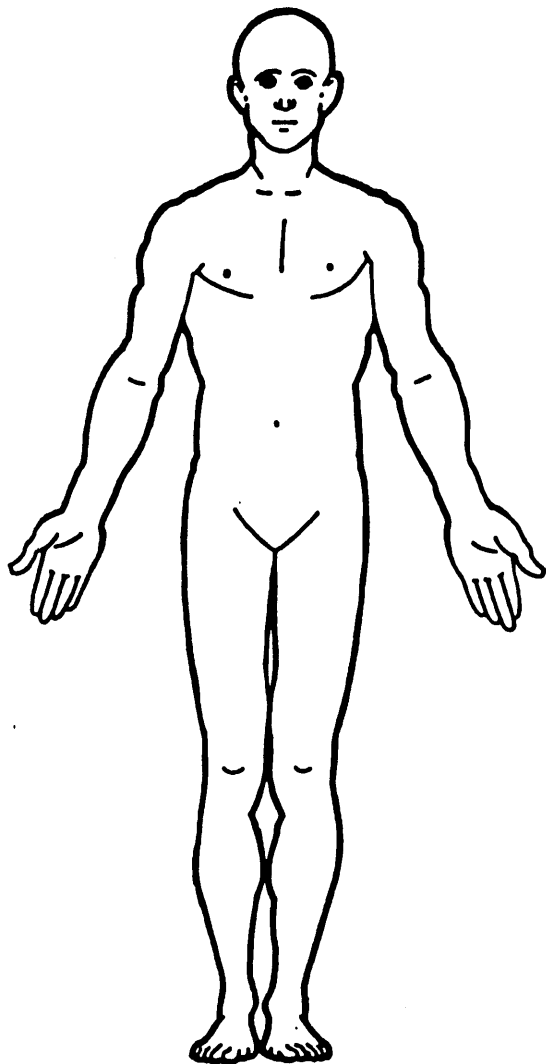

SOURCE OF INJURY DATA**OFFICIAL**

- (1) Autopsy records with or without hospital/medical records
- (2) Hospital/medical records other than emergency room (e.g., discharge summary)
- (3) Emergency room records only (including associated X-rays or other lab reports)
- (4) Private physician, walk-in or emergency clinic

UNOFFICIAL

- (5) Lay coroner report
- (6) E.M.S. personnel
- (7) Interviewee
- (8) Other source (specify): _____
- (9) Police

INJURY SOURCE CONFIDENCE LEVEL

- (1) Certain
- (2) Probable
- (3) Possible
- (9) Unknown

DIRECT/INDIRECT INJURY

- (1) Direct contact injury
- (2) Indirect contact injury
- (3) Noncontact injury
- (7) Injured, unknown source

STRIKING PROFILE

- (0) Injury not from vehicle contact
- (1) Flat-Narrow (< 15 centimeters)
- (2) Flat-Wide (≥ 15 centimeters)
- (3) Rounded (contoured)
- (4) Rounded edge
- (5) Sharp edge
- (8) Other (specify): _____
- (9) Unknown

TYPE OF DAMAGE

- (0) Injury not from vehicle contact
- (1) No damage/contact
- (2) Scratch (Scuff, Cloth Transfer, Smear)
- (3) Dent
- (4) Large deformation
- (5) Cracked, fractured, shattered
- (6) Separated from vehicle
- (7) Noncontact injury
- (8) Other specify: _____
- (9) Unknown

DAMAGE DEPTH

- (0) Injury not from vehicle contact
- (1) No residual damage
- (2) Surface only damage
- (3) Crush depth > 0 to 2 centimeters
- (4) Crush depth > 2 to 5 centimeters
- (5) Crush depth > 5 to 10 centimeters
- (8) Other specify: _____
- (9) Unknown

PEDESTRIAN INJURY CLASSIFICATION**Body Region**

- (1) Head
- (2) Face
- (3) Neck
- (4) Thorax
- (5) Abdomen
- (6) Spine
- (7) Upper Extremity
- (8) Lower Extremity
- (9) Unspecified

Specific Anatomic Structure

- Whole Area**
- (02) Skin - Abrasion
 - (04) Skin - Contusion
 - (06) Skin - Laceration
 - (08) Skin - Avulsion
 - (10) Amputation
 - (20) Burn
 - (30) Crush
 - (40) Degloving
 - (50) Injury - NFS
 - (90) Trauma, other than mechanical

Spine

- (02) Cervical
- (04) Thoracic
- (06) Lumbar

Vessels, Nerves, Organs, Bones, Joints
are assigned consecutive two digit numbers beginning with 02

Level of Injury

Specific injuries are assigned consecutive two-digit numbers beginning with 02.

To the extent possible, within the organizational framework of the AIS, 00 is assigned to an injury NFS as to severity or where only one injury is given in the dictionary for that anatomic structure. 99 is assigned to any injury NFS as to lesion or severity.

Abbreviated Injury Scale

- (1) Minor injury
- (2) Moderate injury
- (3) Serious injury
- (4) Severe injury
- (5) Critical injury
- (6) Maximum (untreatable)
- (7) Injured, unknown severity

Type of Anatomic Structure

- (1) Whole Area
- (2) Vessels
- (3) Nerves
- (4) Organs (includes muscles/ligaments)
- (5) Skeletal (includes joints)
- (6) Head - LOC
- (9) Skin

Head - LOC

- (02) Length of LOC
- (04, 06, 08) Level of Consciousness
- (10) Concussion

Aspect

- (1) Right
- (2) Left
- (3) Bilateral
- (4) Central
- (5) Anterior
- (6) Posterior
- (7) Superior
- (8) Inferior
- (9) Unknown
- (0) Whole region

INJURY SOURCE**FRONT**

- 700 Front bumper
- 701 Front lower valance/spoiler
- 702 Front grille
- 703 Hood edge and/or trim
- 704 Hood ornament (fixed)
- 705 Hood ornament (spring loaded)
- 706 Headlight
- 707 Retractable headlight door (Open/Closed)
- 708 Turn signal/parking lights
- 718 Other front or add on object (specify): _____
- 719 Unknown front object

Left Side Components

- 720 Front fender side surface
- 721 Front antenna
- 722 A1 pillar
- 723 A2 pillar
- 724 B pillar
- 725 C pillar
- 726 D pillar
- 728 Other pillar (specify): _____
- 729 Left side roof rail
- 730 Left side door surface
- 731 Left side door handle
- 732 Left side mirror fixed housing
- 733 Left side folding mirror
- 734 Left side glazing forward of B pillar
- 735 Left side glazing rearward of B pillar
- 736 Left side back fender or quarter panel
- 737 Rear antenna
- 738 Other left side object (specify): _____
- 739 Unknown left side component

Right Side Components

- 740 Front fender side surface
- 741 Front antenna
- 742 A1 pillar
- 743 A2 pillar

744 B pillar

- 745 C pillar
- 746 D pillar
- 748 Other pillar (specify): _____
- 749 Right side roof rail
- 750 Right side door surface
- 751 Right side door handle
- 752 Right side mirror fixed housing
- 753 Right side folding mirror
- 754 Right side glazing forward of B pillar
- 755 Right side glazing rearward of B pillar
- 756 Rear antenna
- 757 Rear fender or quarter panel
- 758 Other right side object (specify): _____
- 759 Unknown right side component

Back Components

- 760 Rear (back) bumper
- 761 Tailgate
- 762 Hatchback, vertical surface
- 768 Other back component (specify): _____
- 769 Unknown back component

Top Components

- 770 Hood surface
- 771 Hood surface reinforced by under hood component
- 772 Front fender top surface
- 773 Cowl area
- 774 Wiper blade & mountings
- 775 Windshield glazing
- 776 Front header
- 777 Roof surface
- 778 Backlight glazing
- 779 Rear header
- 780 Hatchback
- 781 Rear trunk lid
- 788 Other top component (specify): _____
- 789 Unknown top component

Wheels / tires

- 790 Left front wheel / tire
- 791 Right front wheel / tire
- 792 Left rear wheel / tire
- 793 Right rear wheel / tire
- 798 Other wheel / tire (specify): _____
- 799 Unknown wheel / tire

Undercarriage components

- 800 Front crossmember
- 801 Steering assembly/Front suspension
- 802 Oil pan
- 803 Exhaust system pipe
- 804 Transmission
- 805 Drive shaft
- 806 Catalytic converter
- 807 Muffler
- 808 Floor pan
- 809 Fuel tank
- 810 Rear suspension
- 818 Other undercarriage component (specify): _____
- 819 Unknown undercarriage component

Accessories

- 820 Air scoop, deflector
- 821 Cellular or CB radio antenna
- 822 Emergency lights or bar
- 823 Fog lights
- 824 Luggage, ski, or bike rack
- 825 Cargo (specify): _____
- 826 Spare tire
- 827 Spotlight
- 828 Other accessory (specify): _____

Other Object or Vehicle in Environment

- 947 Ground
- 948 Other object (specify): _____
- 949 Unknown object in environment
- 959 Unknown object on contacting vehicle
- 997 Noncontact injury source
- 999 Unknown injury source

OFFICIAL INJURY DATA — SKELETAL INJURIES

Restrained?

No
 Yes

Indicate the Location, Specific Anatomic Structure, Detail (size, depth, fracture type, head injury clinical signs and neurological deficits), and Source of all injuries indicated by official sources (or from PAR or other unofficial sources if medical records and interviewee data are unavailable.)

Blood Alcohol Level (mg/dl)

BAL = .05

(-) TOXICOLOGY

Glasgow Coma Scale Score

GCSS = 3

Units of Blood Given

Units = 1

Arterial Blood Gases

Ph = RAD

PO₂ = COMMINUTED
FX RT SUBTROCANTERIC

PCO₂ = SITE EXTENDS INTO

INTERTROCANTERIC
AREA

HCO₃ = AUT:

COMMINUTED FX'S
RT TIBIA & FIBULA
(LOWER SITE OF HYPER-
MOBILITY IS 7" FROM HEEL
UPPER SITE OF HYPER-MOBILITY
IS 12 1/2" FROM RT HEEL
(BUMPER INJURY)

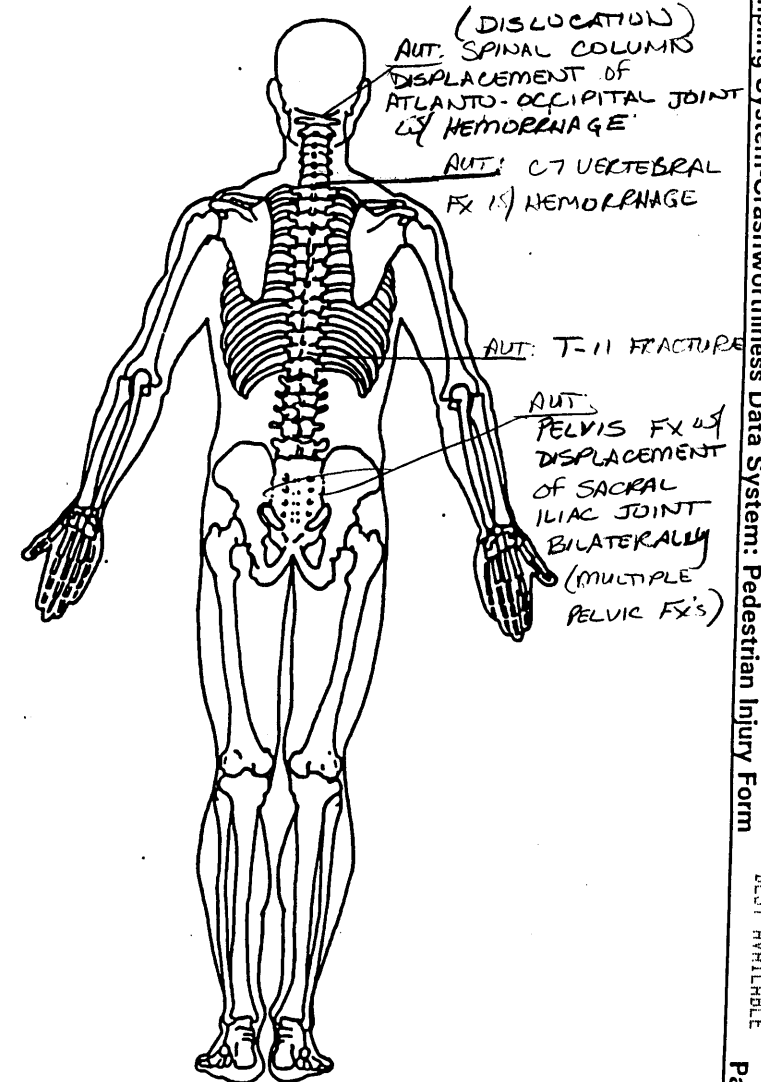
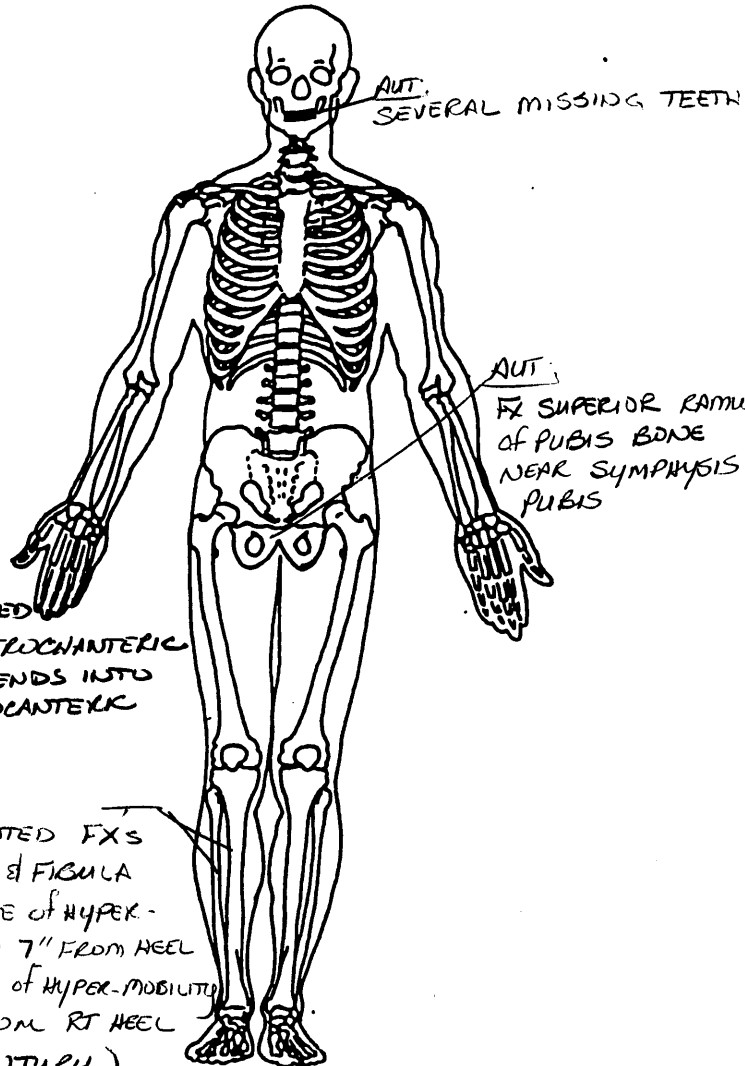

OFFICIAL INJURY DATA — INTERNAL INJURIES

Indicate the Location, Specific Anatomic Structure, Detail (size, depth, fracture type, head injury clinical signs and neurological deficits), and Source of all injuries indicated by official sources (or from PAR or other unofficial sources if medical records and interviewee data are unavailable.)

AUT:

CONTRACOUP
CONTUSIONS, AS WELL
AS MULTIPLE WHITE
MATTER DIFFUSE
EXTERNAL INJURIES
NFS

AUT:

LEFT HEMOTHORAX
NFS

AUT:

SM CONTUSIONS
ON ASCENDING
COLON & LG
TEAR IN
MESOCOLON

AUT:

HEMOPERITONEUM

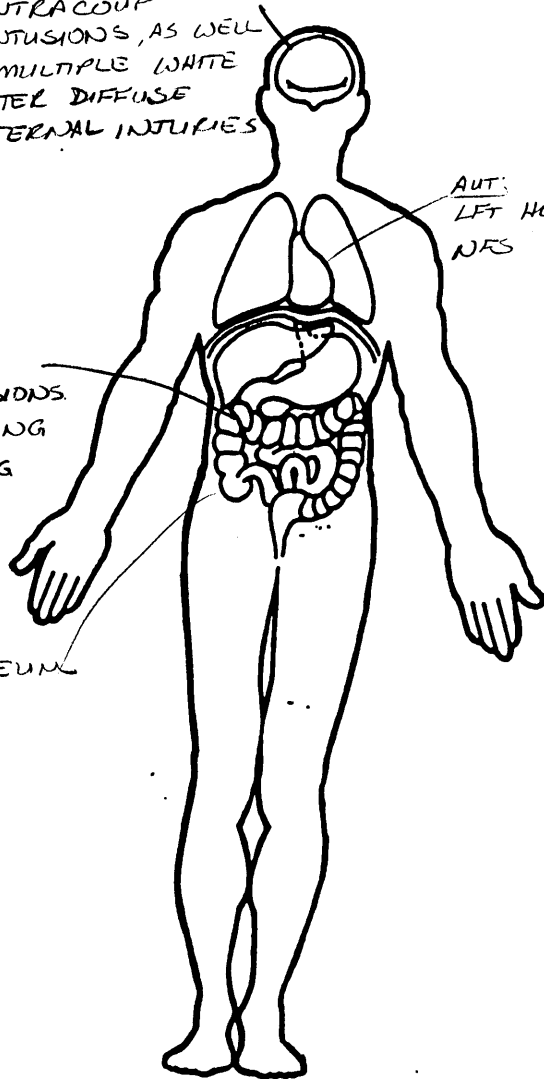

AUT:

SUBARACHNOID
HEMORRHAGE AROUND
CEREBELLUM ASCENDING
FROM SPINAL COLUMN

AUT:

INTRAVENTRICULAR
HEMORRHAGE IN ALL
FOUR VENTRICLES

AUT: PONTOMEDULLARY
JUNCTION IS SEVERED
ON THE RT SIDE & THE
CEREBRAL PEDUNCLE
ON THE RIGHT IS ALSO
LACERATED →
SEVERED

AUT: SEMI-TRANSECTION
& TWO LACERATIONS
ON THE ARCH
OF THE AORTA
& MULTIPLE STRETCH
TEARS ON THE
INTIMA OF THE
THORACIC AORTA
LOWER DOWN

AUT: SPLEEN
LACERATIONS IN
LOWER POLE

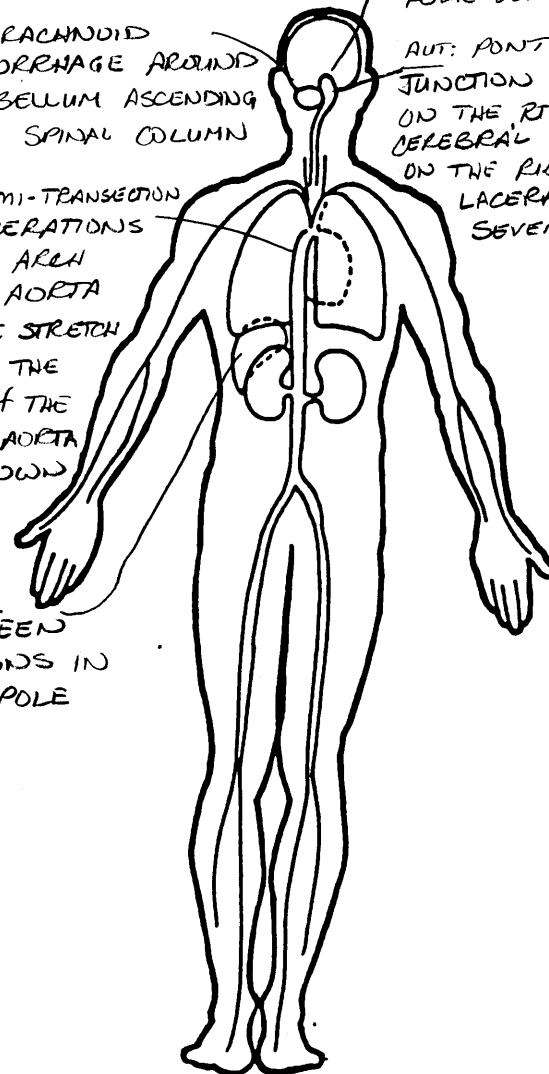



98



198



198



198



198

1

PSU40
CASE 604P

1998 PEDESTRIAN ACCIDENT FORM

IDENTIFICATION

3. Number of General Vehicle Forms Submitted	01	
4. Date of Accident (Month, Day, Year)		98
5. Time of Accident (military time)	2224	

SPECIAL STUDIES - INDICATORS

6. SS15	0	7. SS16	1	8. SS17	0	9. SS18	0	10. SS19	0
---------	---	---------	---	---------	---	---------	---	----------	---

NUMBER OF EVENTS

11. Number of Recorded Events in This Accident	01
01	

PSU40
CASE 604P

1998 PEDESTRIAN ACCIDENT FORM

PEDESTRIAN ACCIDENT EVENTS

Accident Sequence Number	Vehicle Number	Class of Vehicle	General Area of Damage	Veh. Num. or Obj. Cont.	Class of Vehicle	General Area of Damage
12. 01	13. 01	14. 11	15. F	16. 72	17. 00	18. 0

01

PSU40
CASE 604P

1998 PEDESTRIAN ASSESSMENT FORM

VEHICLE 01 PEDESTRIAN 01

PEDESTRIAN'S CHARACTERISTICS

4. Pedestrian's Age	72
5. Pedestrian's Sex	1
6. Pedestrian's Overall Height	170
7. Pedestrian's Height - Ground to Knee	99
8. Pedestrian's Height - Ground to Hip	999
9. Pedestrian's Height - Ground to Shoulder	999
10. Pedestrian's Weight	073

PEDESTRIAN'S PRE-AVOIDANCE ACTIONS

11. Pedestrian's Attitude	1
12. Pedestrian's Motion	1
13. Pedestrian's Actions Relative to Vehicle	01
14. Pedestrian's Body (Chest) Orientation Relative to Striking Vehicle Prior to Avoidance Actions	9

PEDESTRIAN'S AVOIDANCE ACTIONS

15. Pedestrian's First Avoidance Actions	99
--	----

PEDESTRIAN'S ORIENTATION AT IMPACT

16. Pedestrian's Head Orientation at Initial Impact	9
17. Pedestrian's Body (Chest) Orientation at Initial Impact	9
18. Pedestrian's Arm Orientation at Initial Impact	09
19. Pedestrian's Leg Orientation at Initial Impact	99
20. Vehicle/Pedestrian's Interaction	02

OFFICIAL RECORDS

21. Police Reported Alcohol Presence For Pedestrian	0
22. Alcohol Test Result For Pedestrian	05
23. Police Reported Other Drug Presence For Pedestrian	0
24. Other Drug Specimen Test Result For Pedestrian	1

INJURY CONSEQUENCES

25. Injury Severity (Police Rating)	4
26. Treatment - Mortality	1
27. Type of Medical Facility (for Initial Treatment)	1
28. Hospital Stay	00
29. Working Days Lost	62

(COMPLETED BY THE ZONE CENTER)

30. Glasgow Coma Scale Score	01
31. Was the Pedestrian Given Blood?	1
32. Arterial Blood Gases	01
33. Time to Death	99
34. 1st Medically Reported Cause of Death	12
35. 2nd Medically Reported Cause of Death	13
36. 3rd Medically Reported Cause of Death	11
37. Number of Recorded Injuries for This Pedestrian	17

011

INTRA ERRORS

OHH178 1 NOT FOUND in error message file. Please Contact Hotli

01

PSU40
CASE 604P
VEHICLE 01 PEDESTRIAN 01

1998 PEDESTRIAN INJURY FORM

PEDESTRIAN INJURY DATA

	Source of Inj. Data	Body Reg.	Type of Anat. Struc.	Spec. Anat. Struc.	Lev. of Inj.	AIS Sev.	Asp.	Inj. Source	Inj. Source Level	Dir./ Indir. Inj.	Str. Pro.	Type of Dmg.	Dmg. Dep.
01.	1	1	9	06	02	1	6	770	2	1	2	3	4
02.	1	2	5	14	06	1	8	770	2	1	2	3	4
03.	1	8	5	26	00	2	5	702	1	1	2	5	2
04.	1	8	5	28	00	3	6	702	1	1	2	5	2
05.	1	8	5	34	22	3	1	700	1	1	1	2	2
06.	1	8	5	16	06	2	1	700	1	1	1	2	2
07.	1	6	5	04	16	2	7	770	1	1	2	3	4
08.	1	6	5	02	16	2	6	770	2	1	2	3	4
09.	1	6	5	02	08	2	6	770	2	1	2	3	4
10.	1	1	4	04	66	3	6	770	2	1	2	3	4
11.	1	1	4	06	12	3	9	770	2	1	2	3	4
12.	1	1	4	02	12	6	8	770	2	1	2	3	4
13.	1	4	2	02	08	4	4	770	2	1	2	3	4
14.	1	5	4	42	20	2	2	702	1	1	2	5	2
15.	1	5	4	08	10	2	8	702	1	1	2	5	2
16.	1	5	4	08	20	2	8	702	1	1	2	5	2
17.	2	8	5	18	18	3	1	703	1	1	4	3	4

01
PSU40
CASE 604P
VEHICLE 01

1998 PEDESTRIAN GENERAL VEHICLE FORM

VEHICLE IDENTIFICATION

4. Vehicle Model Year 96
5. Vehicle Make 12
6. Vehicle Model 401
7. Body Type 14
8. Vehicle Identification Number 1FMCU24X1TU

OFFICIAL RECORDS

9. Police Reported Travel Speed 999
10. Speed Limit 048
11. Police Reported Alcohol Presence For Driver 9
12. Alcohol Test Result For Driver 96
13. Police Reported Other Drug Presence 9
14. Other Drug Specimen Test Result for Driver 9

VEHICLE WEIGHT ITEMS

15. Vehicle Curb Weight 1,670

16. Vehicle Cargo Weight 9,990

OTHER DATA

17. Vehicle Special Use (This Trip) 0

RECONSTRUCTION DATA (COMPLETED BY THE ZONE CENTER)

18. Impact Speed +999

19. Accuracy Range of Impact Speed Estimate 9

20. Data Source of Impact Speed 0

PRECRAASH DATA

21. Driver's Attention to Driving 9

22. Pre-Event Vehicle Movement 01

PRECRAASH DATA (continued)

23. Critical Precrash Event 80

24. Attempted Avoidance Maneuver 99

25. Precrash Stability After Avoidance Maneuver 9

26. Precrash Directional Consequences of
Avoidance Manuver (Corrective Action) 9

ENVIRONMENTAL DATA

27. Relation to Junction 2

28. Trafficway Flow 1

29. Number of Travel Lanes 4

30. Roadway Alignment 1

31. Roadway Profile

1

32. Roadway Surface Type	2
33. Roadway Surface Condition	2
34. Traffic Control Device	0
35. Traffic Control Device Functioning	0
36. Light Conditions	3
37. Atmospheric Conditions	2

01
 PSU40 1998 PEDESTRIAN EXTERIOR VEHICLE FORM
 CASE 604P
 VEHICLE 01

VEHICLE DIMENSIONS

4. Original Wheelbase	258
5. Original Average Track Width	149
6. Hood Material	3
7. Hood Original Equip. Manufacturer	1
8. Hood Length	111
9. Hood Width Forward Opening	143
10. Hood Width Midway	145
11. Hood Width Rear Opening	145
12. Hood/Fender Vertical/Lateral Crush From Pedestrian	2
13. Windshield Contact Damage From Pedestrian Contact	9

FRONT CONTACT DAMAGE

FRONT VERTICAL MEASUREMENTS

14. Front Bumper Cover Material	1	15. Front Bumper Reinforcement Mat.	1
16. Front Bumper-Bottom Height	050	17. Front Bumper-Top Height	068
18. Forward Hood Opening	098	19. Front Bumper Lead	07

FRONT WRAP DISTANCE MEASUREMENTS

20. Ground to Fwd. Hood Opening	100	21. Ground to Front/Top Transition Pt	108
22. Ground to Rear Hood Opening	208	23. Ground to Base of Windshield	220
24. Ground to Top of Windshield	291	25. Ground to Head Contact	999

SIDE CONTACT DAMAGE

SIDE VERTICAL MEASUREMENTS

26. Ground Clearance	000
27. Side Bumper-Bottom Height	000
28. Side Bumper-Top Height	000

29. Centerline of Wheel	000
30. Top of Tire	000
31. Top of Wheel Well Opening	000
32. Bottom of A-Pillar at Windshield	000
33. Top of A-Pillar at Windshield	000
34. Top of Side View Mirror	000

SIDE CONTACT DAMAGE (continued)

SIDE LATERAL MEASUREMENTS

35. Centerline to A-Pillar at Bottom of Windshield	000
36. Centerline to A-Pillar at Top of Windshield	000
37. Centerline to Maximum Side View Mirror Protrusion	000

SIDE WRAP DISTANCE MEASUREMENTS

38. Ground to Side/Top Transition	000
39. Ground to Hood Edge	000
40. Ground to Centerline of Hood (Origin)	000
41. Ground to Head Contact	000

0

PSU40
CASE 604P
CURRENT VERSION: 11.0

ERROR SUMMARY SCREEN
PEDESTRIAN STUDY

99

FORM NAME	NUMBER OF DOLLAR SIGNS	NUMBER OF LEVEL 1 ERRORS	NUMBER OF LEVEL 2 ERRORS	VERSION NUMBER CONSISTENT
Pedestrian Accident	0	0	0	Y
Pedestrian Assessment	0	0	0	Y
Pedestrian Injury	0	0	0	Y
Pedestrian General Vehicle	0	0	0	Y
Pedestrian Exterior Vehicle	0	0	0	Y
Total Inter Errors		0	0	
Total Case Errors	0	0	0	